











18 ENT
HNO
ORL
ORL
ORL



Toynbee				
				
18-801-03	18-802-03	18-803-03	18-804-03	3.6 cm - 1 ½"
Fig. 1 4.5 mm Ø	Fig. 2 5.5 mm Ø	Fig. 3 6.5 mm Ø	Fig. 4 7.5 mm Ø	
Set for adults Satz für Erwachsene Juego para adultos Jeu pour adultes Serie per adulti				
18-801-00	Set of 4 pcs. Fig. 1 - 4			



Richnau Holmgren				
				
18-805-00	18-806-01	18-807-02	18-808-03	
Fig. 0 3 mm Ø	Fig. 1 4 mm Ø	Fig. 2 5 mm Ø	Fig. 3 6 mm Ø	

 add "B" with catalogue part number if required in black TiN coating

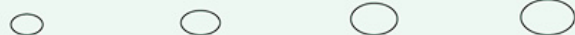

Gruber

18-809-01	18-810-02	18-811-03	18-812-04
Fig. 1	Fig. 2	Fig. 3	Fig. 4
a = 4.5 mm Ø	a = 5.5 mm Ø	a = 6.5 mm Ø	a = 7.5 mm Ø

Set for adults
Satz für Erwachsene
Juego para adultos
Jeu pour adultes
Serie per adulti

18-809-00 Set of 4 pcs. Fig. 1 - 4

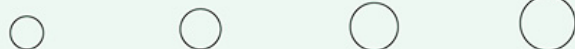

Gruber

18-813-01	18-814-02	18-815-03	18-816-04
Fig. 1	Fig. 2	Fig. 3	Fig. 4
a = 4.5 mm Ø	a = 5.5 mm Ø	a = 6.5 mm Ø	a = 7.5 mm Ø

Set for adults
Satz für Erwachsene
Juego para adultos
Jeu pour adultes
Serie per adulti

18-813-00 Set of 4 pcs. Fig. 1 - 4

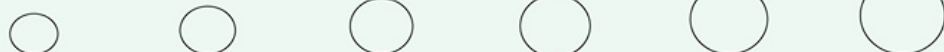

Zöllner

18-817-01	18-818-02	18-819-03	18-820-04	18-821-05	18-822-06
Fig. 1	Fig. 2	Fig. 3	Fig. 4	Fig. 5	Fig. 6
5.5 x 6.5 mm	6.5 x 7.5 mm	7.5 x 8.5 mm	8.5 x 9.5 mm	9.5 x 10.5 mm	10.5 x 11.5 mm

Set for adults, black
Satz für Erwachsene, schwarz
Juego para adultos, negro
Jeu pour adultes, noir
Serie per adulti, nero

18-817-00 Set of 6 pcs. Fig. 1 - 6

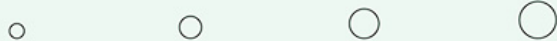

Politzer

18-823-01	18-824-02	18-825-03	18-826-04
Fig. 1	Fig. 2	Fig. 3	Fig. 4
2 mm Ø	3 mm Ø	4 mm Ø	5 mm Ø

Set for adults
Satz für Erwachsene
Juego para adultos
Jeu pour adultes
Serie per adulti

18-823-00 Set of 4 pcs. Fig. 1 - 4

add "B" with catalogue part number if required in black TiN coating



Boucheron				
18-827-01	18-828-02	18-829-03	18-830-04	18-827-00
Fig. 1 4.5 mm Ø	Fig. 2 5.5 mm Ø	Fig. 3 6.5 mm Ø	Fig. 4 7.5 mm Ø	Set of 4 pcs. Fig. 1 - 4
Set for adults Satz für Erwachsene Juego para adultos Jeu pour adultes Serie per adulti				



Boucheron				
18-831-00	18-832-01	18-833-02	18-831-00	
Fig. 0 3.0 mm Ø	Fig. 1 4.5 mm Ø	Fig. 2 5.5 mm Ø	Set of 3 pcs. Fig. 0 - 2	
Set for children Satz für Kinder Juego para niños Jeu pour enfants Serie per bambini				



Hartmann				
18-834-01	18-835-02	18-836-03	18-837-04	18-834-00
Fig. 1 4.5 mm Ø	Fig. 2 5.5 mm Ø	Fig. 3 6.5 mm Ø	Fig. 4 7.5 mm Ø	Set of 4 pcs. Fig. 1 - 4
Set for adults Satz für Erwachsene Juego para adultos Jeu pour adultes Serie per adulti				



Hartmann				
18-838-01	18-839-02	18-840-03	18-841-04	18-842-05
Fig. 1 2.0 mm Ø	Fig. 2 3.5 mm Ø	Fig. 3 5.0 mm Ø	Fig. 4 6.5 mm Ø	Fig. 5 7.5 mm Ø
Set for adults, black Satz für Erwachsene, schwarz Juego para adultos, negro Jeu pour adultes, noir Serie per adulti, nero				
18-838-00 Set of 5 pcs. Fig. 1 - 5				



Tumarkin				
18-127-00	18-127-01	18-127-02	18-127-03	18-127-04
Fig. 0	Fig. 1	Fig. 2	Fig. 3	Fig. 4
18-127-05	18-127-06	18-127-07	18-127-08	
Fig. 5	Fig. 6	Fig. 7	Set of 8 for adults. Fig. 0 - 7	

add "B" with catalogue part number if required in black TiN coating



Siegle

18-843-00

Fig. 1

6.5 mm Ø

Setcomplete
Satz komplett
Juego completo
Jeu complet
Serie completa



18-844-01

Fig. 2

7.0 mm Ø



18-845-02

Fig. 3

8.0 mm Ø



18-846-00

Magnifyer, alone
Lupenkörper, allein
Lupa, sola
Loupe, seule
Lente, solo



Bruenings

18-847-00

Fig. 1

6.5 mm Ø

Setcomplete
Satz komplett
Juego completo
Jeu complet
Serie completa



18-848-01

Fig. 2

7.5 mm Ø



18-849-02

Fig. 3

8.5 mm Ø



18-850-01

Fig. 4

9.5 mm Ø



18-851-00

Magnifyer, alone
Lupenkörper, allein
Lupa, sola
Loupe, seule
Lente, solo



Lucae
18-852-00

c 128
variable up to h (engl. b)
verschiebbar bis h
variable hasta h (esp. si)
variable jusqu'à h (franc. si)
regolabile fino a h

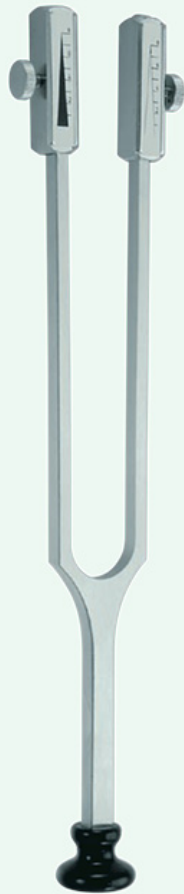

Rydel-Seiffer
18-853-00

C 64 / c 128

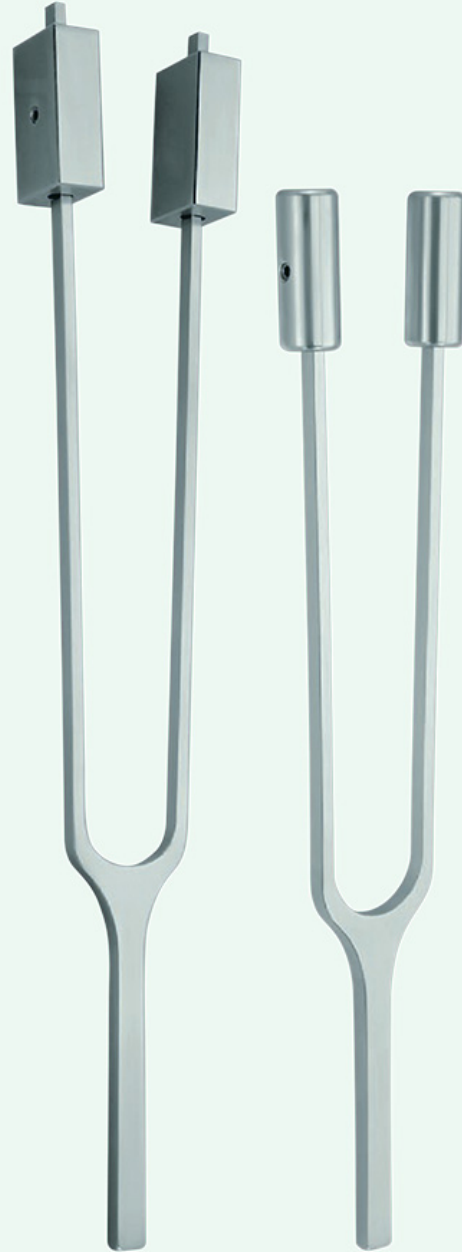

French
18-854-00

C₂ 16
with clamps C 64, without clamps c 128
mit Dämpfer C64, ohne Dämpfer c 128
con sordinas C 64, sin sordinas c 128
avec curseurs C 64, sans curseurs c 128
con cursori C 64, senza cursori c 128

18-855-00

C₁ 32

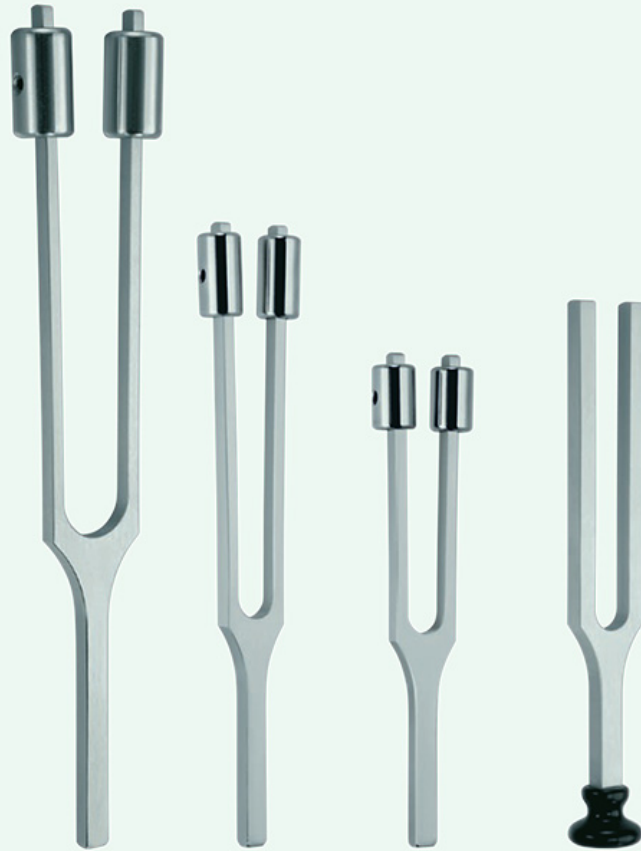

Hartmann

18-856-00

C 64

18-857-00

c 128

18-858-00

c' 256

18-859-00

a' 440

Noise drum
Lärmtrommel
Aparato de ruido
Assourdisseur
Assordatore



Barany

18-860-00

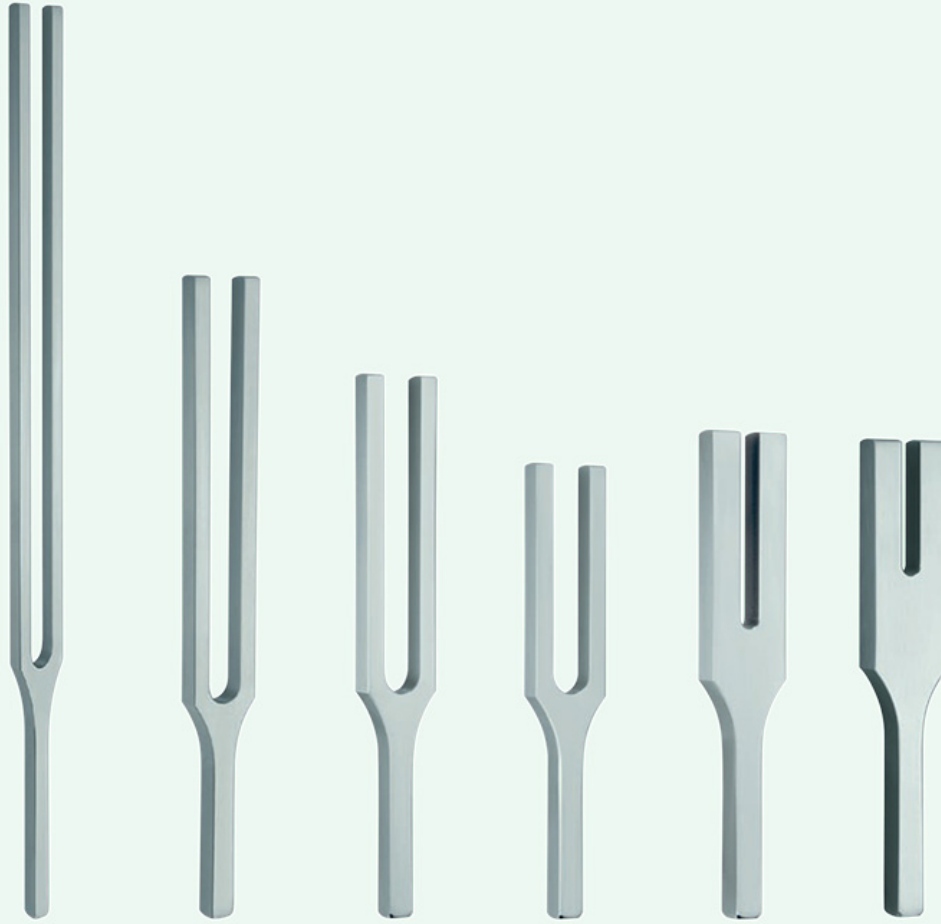

Hartmann

18-861-00	18-862-00	18-863-00	18-864-00	18-865-00	18-866-00
c 128	c ¹ 256	c ² 512	c ³ 1024	c ⁴ 2048	c ⁵ 4096



Hartmann

18-867-00	Set of 5 pcs consisting:
18-857-00	c 128
18-858-00	c ¹ 256
18-863-00	c ² 512
18-864-00	c ³ 1024
18-865-00	c ⁴ 2048

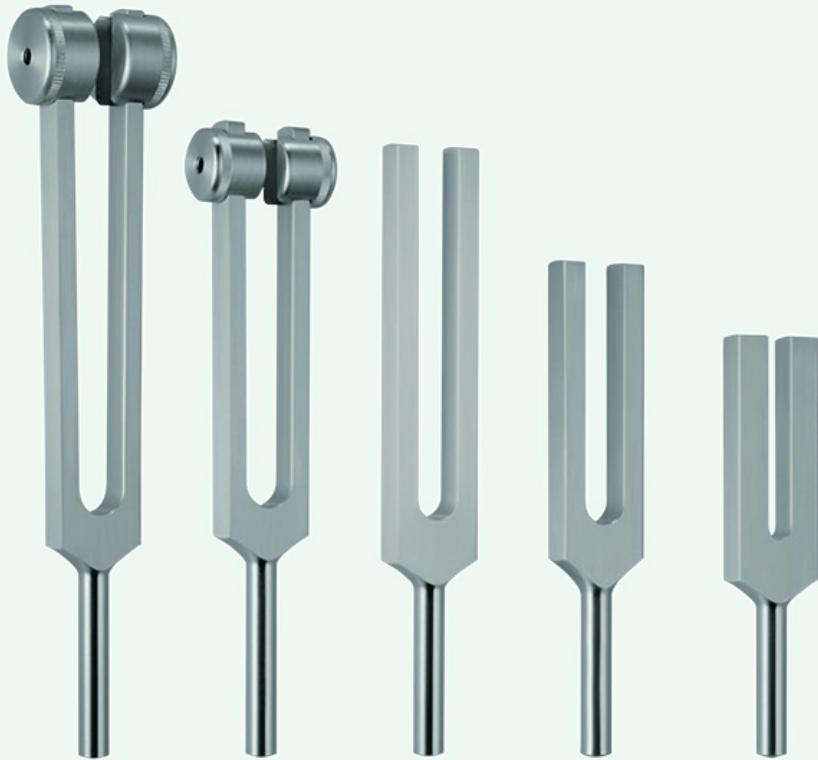

















18-868-00	18-869-00	18-870-00	18-871-00	18-872-00
c 128	c ¹ 256	c ² 512	c ³ 1024	c ⁴ 2048



18-873-00	Set of 5 pcs consisting:
18-868-00	c 128
18-869-00	c ¹ 256
18-870-00	c ² 512
18-871-00	c ³ 1024
18-872-00	c ⁴ 2048



								
Buck								
18-874-16	18-875-16	18-876-16	18-877-16	18-878-16	18-879-16	18-880-16	18-881-16	16.5 cm - 6 1/2"
Fig. 000	Fig. 00	Fig. 0	Fig. 1	Fig. 2	Fig. 3	Fig. 4	Fig. 5	
blunt								
stumpf								
roma								
mousse								
smussa								

								
Buck								
18-882-16	18-883-16	18-884-16	18-885-16	18-886-16	18-887-16	18-888-16	18-889-16	16.5 cm - 6 3/4"
Fig. 000	Fig. 00	Fig. 0	Fig. 1	Fig. 2	Fig. 3	Fig. 4	Fig. 5	
sharp								
scharf								
cortante								
tranchante								
tagliente								

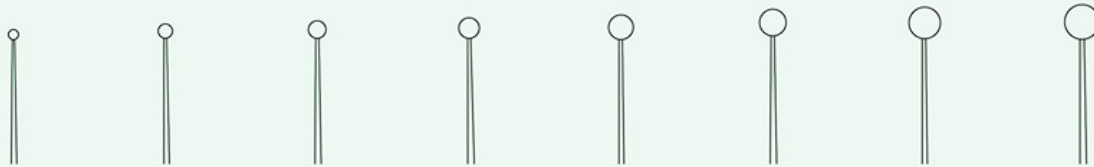

Buck

18-890-16	18-891-16	18-892-16	18-893-16	18-894-16	18-895-16	18-896-16	18-897-16	16.5 cm - 6 ½"
-----------	-----------	-----------	-----------	-----------	-----------	-----------	-----------	----------------

Fig. 000	Fig. 00	Fig. 0	Fig. 1	Fig. 2	Fig. 3	Fig. 4	Fig. 5	
----------	---------	--------	--------	--------	--------	--------	--------	--

curved, blunt
gebogen, stumpf
curva, cortante
courbe, tranchante
curva, smussa

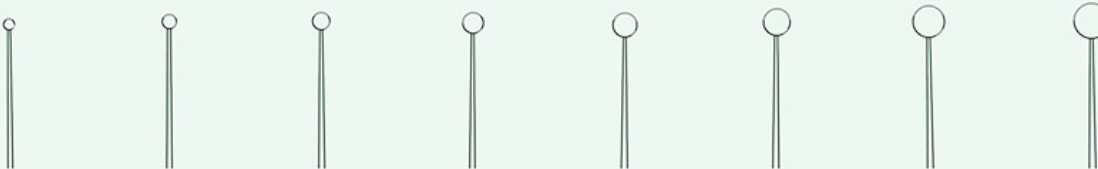

Buck

18-898-16	18-899-16	18-900-16	18-901-16	18-902-16	18-903-16	18-904-16	18-905-16	16.5 cm - 6 ½"
-----------	-----------	-----------	-----------	-----------	-----------	-----------	-----------	----------------

Fig. 000	Fig. 00	Fig. 0	Fig. 1	Fig. 2	Fig. 3	Fig. 4	Fig. 5	
----------	---------	--------	--------	--------	--------	--------	--------	--

curved sharp
gebogen, scharf
curva, aguda
courbe, pointue
curva, tagliente

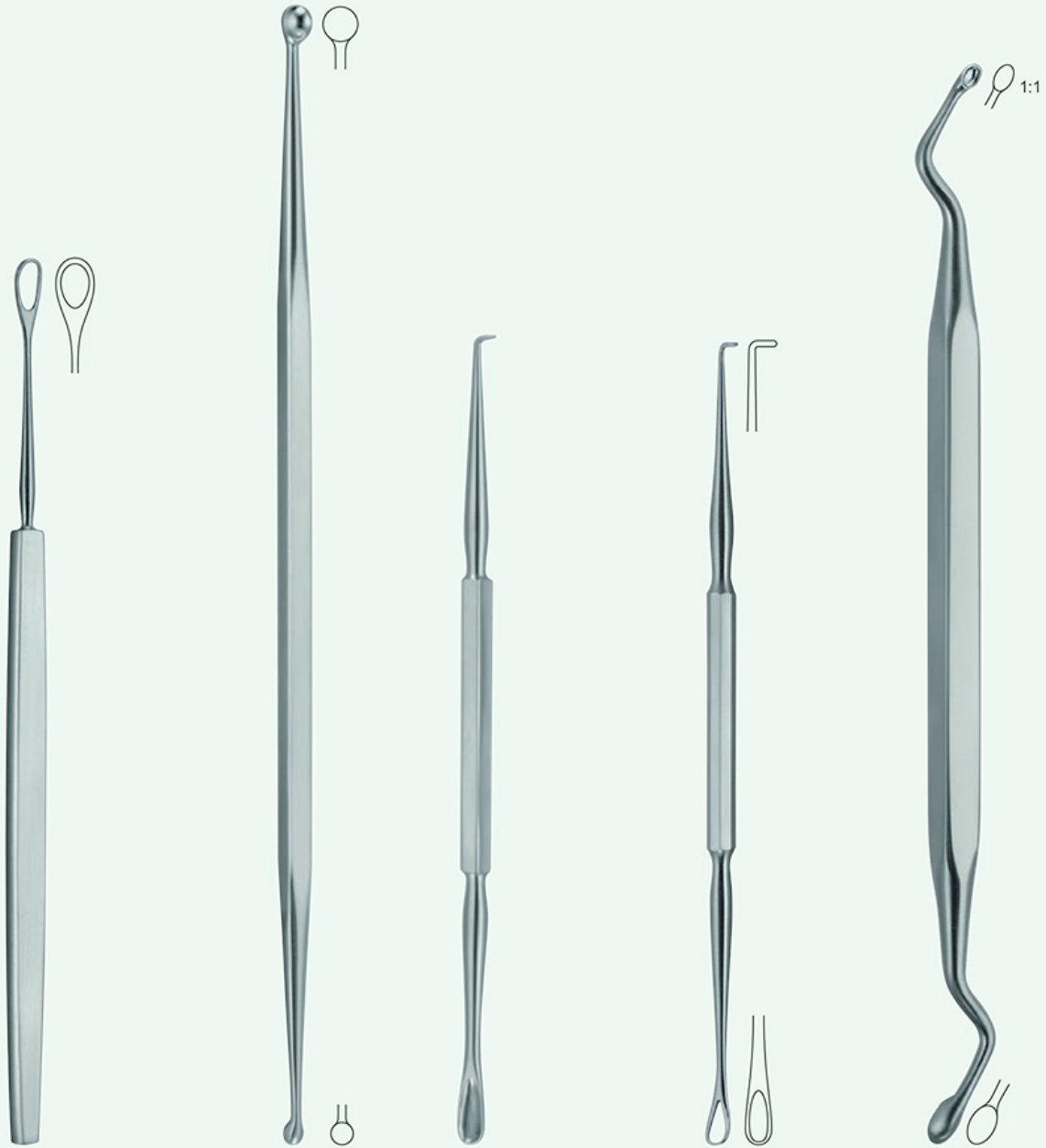

Langenbeck

18-906-13

13 cm - 5"

blunt
 stumpf
 roma
 mousse
 smussa

Jansen

18-907-17

17 cm - 6 3/4"

sharp
 scharf
 cortante
 tranchante
 acuta

Gross

18-908-12

12 cm - 4 3/4"

sharp, not fenestrated
 scharf, voll
 cortante, pieno
 tranchante, pleine
 acuta, pieno

Macal

18-909-12

12 cm - 4 3/4"

blunt, fenestrated
 stumpf, gefenstert
 romas, fenestrada
 mousse, fenêtrée
 smussa, fenestrata

Jansen

18-910-16

16 cm - 6 1/4"

sharp
 scharf
 cortante
 tranchante
 acuta



Billeau

18-911-16

18-912-16

18-913-16

16.5 cm - 6 ½"



Lucae

18-914-14

18-915-14

18-916-14

14 cm - 5 ½"



Wagener

18-917-14

18-918-14

18-919-14

18-920-14

18-921-14

18-922-14

18-923-14

14 cm - 6 ½"

Ear hooks – knives
Ohrhäkchen – Messer
Ganchos – cuchillos auriculares
Crochets – couteaux auriculaires
Ganci per le orecchie - coltelli



Day

18-924-16



18-925-16

16 cm - 6 ¼"



Muck

18-926-13

13.5 cm - 5 ¼"



Gerzog-Sexton

18-927-17

17 cm - 6 ¾"



Poltzer
18-928-16
15 cm - 6"



Gerzog
18-929-16
16 cm - 6 ¼"



Buck
18-930-16
16 cm - 6 ¼"



Lucae
18-931-18



18-932-18 18 cm - 7"



Lucae
18-933-19
19 cm - 7 ½"



Poltzer
18-934-17
17 cm - 6 ¾"



Poltzer
18-935-16
16 cm - 6 ¼"
Needle vertical
Nadel senkrecht
Aguja vertical
Aiguille verticale
Ago verticale



18-936-16
16 cm - 6 ¼"
Needle horizontal
Nadel waagrecht
Aguja horizontal
Aiguille horizontale
Ago orizzontale



Littauer
 18-942-12 16.5 cm - 6 3/4"

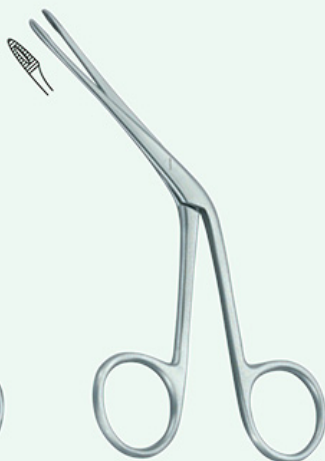

Hartmann
 18-943-12 16.5 cm - 6 3/4"

delicate jaw
 feines Modell
 modelo fino
 modèle fin
 modello fino



Hartmann
 18-944-14 14 cm - 5 3/4"

normal jaw
 normales Modell
 modelo estandard
 modèle standard
 modello standard



Quire
 18-945-10 10.5 cm - 4 1/4"

Foreign body lever
 Fremdkörperhebel
 Elevador para cuerpos extraños
 Levier pour corps étrangers
 Leva per corpi estranei



Buck
 18-946-11 11.5 cm - 4 1/4"

Foreign body forceps
 Fremdkörperzängchen
 Pinza para cuerpos extraños
 Pince pour corps étrangers
 Pinza per corpi estranei

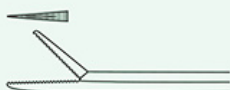

Hartmann-Wullstein

18-947-08 x = 8.5 cm - 3 1/4"



Hartmann-Wullstein

18-948-08 x = 8.5 cm - 3 1/4"
1 mm Ø



Hartmann

18-949-01 x = 8.5 cm - 3 1/4"
18-949-02 x = 14 cm - 5 1/4"
18-949-03 x = 16 cm - 6 1/4"



Hartmann

18-950-08 x = 8.5 cm - 3 1/4"
18-950-14 x = 14 cm - 5 1/2"

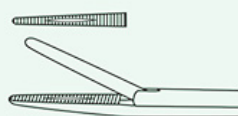

Hartmann-Noyes

18-951-09 x = 9 cm - 3 1/2"
1 mm Ø



Struempel

18-952-08 0°
x = 8.5 cm - 3 1/4"



18-953-08 45°



18-954-08 90°



Hartmann-Weingärtner

18-955-08 x = 8.5 cm - 3 1/4"



Hartmann

18-956-01 2.0 mm Ø
18-956-02 2.5 mm Ø
18-956-03 3.0 mm Ø
x = 8.5 cm - 3 1/4"



McGee

18-957-00 3.5 mm x 0.8 mm

Wire bending forceps
 Drahtbiegezängchen
 Pinza para plegar alambres
 Pince pour plier fils métalliques
 Pinza per piegare fili metallici

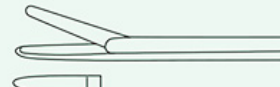

Fuller

18-958-08 8 cm - 3 1/4"

Introducing forceps for teflon prosthesis
 Einführungszängchen für Teflonprothesen
 Pinza para introducir para prótesis de teflon
 Pince pour introduction pour prothèses de téflon
 Pinza per introduzione di protesi in teflon



Dieter

18-959-08

up-cutting
 oben schneidend
 corte arriba
 coupe en haut
 tagliente in alto

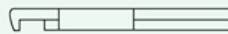

18-960-08

down-cutting
 unten schneidend
 corte abajo
 coupe en bas
 tagliente in basso



18-961-08

right-cutting
 rechts schneidend
 corte derecha
 coupe à droite
 tagliente a destra

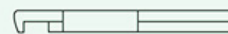

18-962-08

left-cutting
 links schneidend
 corte izquierda
 coupe à gauche
 tagliente a sinistra

x = 8 cm - 3 1/4"

Malleus nipper
 Hammerkopfzängchen
 Pinza para cabezal del martillo
 Pince pour l'os marteau
 Pinza per testa del martelletto

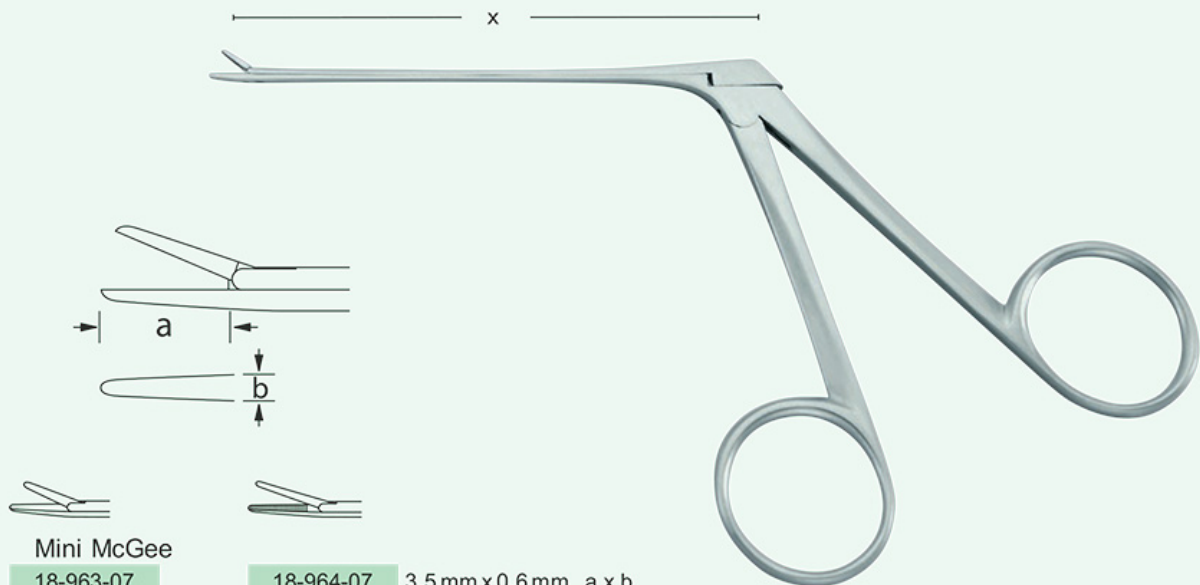

Mini McGee
18-963-07
x = 75 mm - 3"

straight, smooth
gerade, glatt
recta, lisa
droit, lisse
retta, liscia

18-964-07 3.5 mm x 0.6 mm a x b
x = 75 mm - 3"

straight, serrated
gerade, gerieft
recta, estriada
droit, strié
retta, zigrinata



18-965-07

x = 75 mm - 3"
straight, smooth
gerade, glatt
recta, lisa
droit, lisse
retta, liscia



18-966-07

x = 75 mm - 3"
straight, serrated
gerade, gerieft
recta, estriada
droit, strié
retta, zigrinata



18-967-01 3.5 mm 0.6 mm a x b

18-867-02 4.0 mm 0.8 mm a x b

x = 75 mm - 3"
curved upwards, serrated
aufgebogen, gerieft
curvada arriba, estriada
coudé en haut, strié
curvata in alto, zigrinata



18-967-03

18-967-04

x = 75 mm - 3"
curved to right, serrated
rechts gebogen, gerieft
curvada a la derecha, estriada
coudé à droite, strié
curvata a desrta, zigrinata



18-967-05

18-967-06

x = 75 mm - 3"
curved to left, serrated
links gebogen, gerieft
curvada a la izquierda, estriada
coudé à gauche, strié
curvata a shistra, zigrinata



18-967-07 3.5 mm x 0.6 mm a x b

18-967-08 4.0 mm x 0.8 mm a x b

x = 75 mm - 3"
angled down, serrated
abwärts gebogen, gerieft
curvada à bajo, estriada
coudé en bas, strié
curvata in basso zigrinata

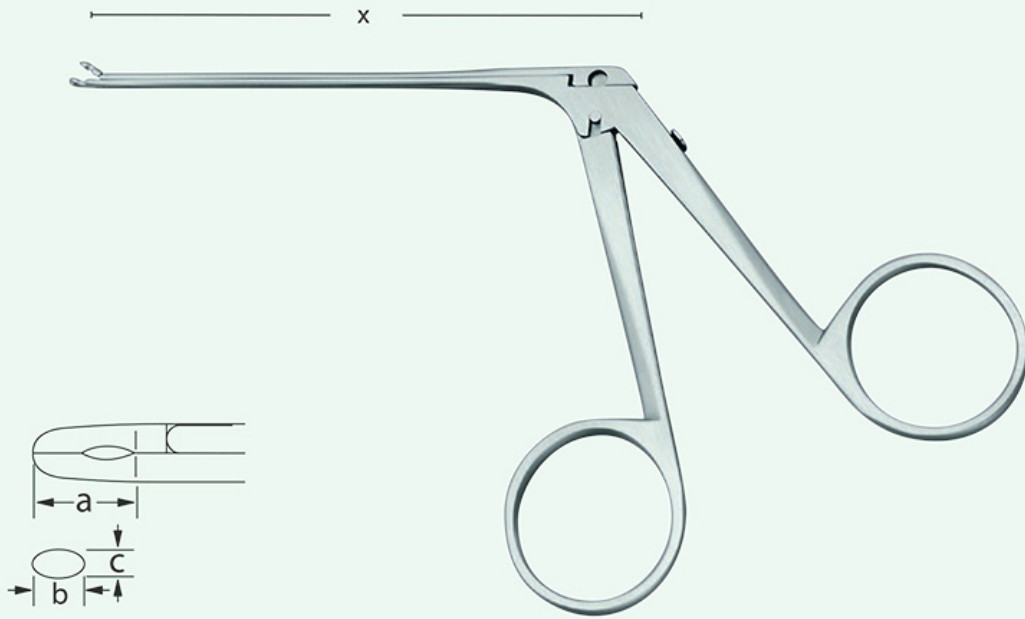

Nikki

18-968-07

x = 75 mm - 3"

straight, oval
 gerade, oval
 recta, oval
 droit, ovale
 retta, ovale



18-969-07

x = 75 mm - 3"

curved upwards, oval
 aufgebogen, oval
 curvada arriba, oval
 coudé en haut, ovale
 curvata in alto, ovale



18-970-07

x = 75 mm - 3"

curved to left, oval
 links gebogen, oval
 curvada a la izquierda, oval
 coudé à gauche, ovale
 curvata a sinistra, ovale

a = 4.0 mm
 b = 1.0 mm x c = 0.9 mm



18-971-07

x = 75 mm - 3"

curved to right, oval
 rechts gebogen, oval
 curvada a la derecha, oval
 coudé à droite, ovale
 curvata a destra, ovale



18-972-07

x = 75 mm - 3"

curved downwards, oval
 abwärts gebogen, oval
 curvada a bajo, oval
 coudé en bas, ovale
 curvata in basso, ovale

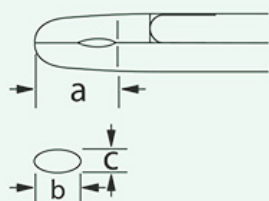

Cobson

18-973-01

18-973-02

x = 8 cm - 3 1/4"

straight, oval
gerade, oval
recta, oval
droit, ovale
retta, ovale



18-975-01

18-975-02

x = 8 cm - 3 1/4"

curved to right, oval
rechts gebogen, oval
curvada a la derecha, oval
coudé à droite, ovale
curvata a destra, ovale



a = 3.5 mm

18-974-01 b = 0.6 mm x c = 0.5 mm

a = 4.0 mm

18-974-02 b = 1.0 mm x c = 0.9 mm

curved upwards, oval
aufgebogen, oval
curvada arriba, oval
coudé en haut, ovale
curvata in alto, ovale



a = 3.5 mm

18-976-01 b = 0.6 mm x c = 0.5 mm

a = 4.0 mm

18-976-02 b = 1.0 mm x c = 0.9 mm

curved to left, oval
aufgebogen, oval
curvada arriba, oval
coudé à gauche, ovale
curvata in alto

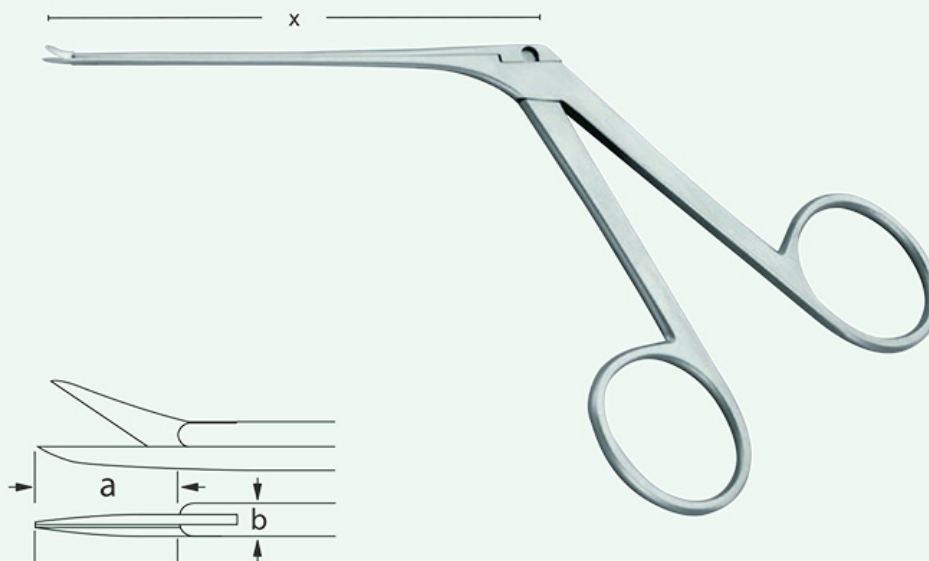

Belucci

18-977-07

x = 7.5 cm - 3"
 straight, sharp/sharp
 gerade, spitz/spitz
 recta, aguda/aguda
 droit, pointue/pointue
 retta, acuta/acuta

very fine
 sehr fein
 muy fina
 très fine
 molto delicata



18-978-07 4.0 mm x 0.8 mm

x = 7.5 cm - 3"
 curved upwards, blunt/blunt
 aufgebogen, stumpf/stumpf
 curvada arriba, roma/roma
 courbées en haut, mousse/mousse
 curvata in alto, smussa/smussa



Belucci

18-979-07

x = 7.5 cm - 3"
 a x b
 curved to right, sharp/sharp
 rechts gebogen, spitz/spitz
 curvada a la derecha, aguda/aguda
 coudé à droite, pointue/pointue
 curvata a destra, acuta/acuta

very fine
 sehr fein
 muy fina
 très fine
 molto delicata



18-980-07 4.0 mm x 0.8 mm

x = 7.5 cm - 3"
 curved to left, sharp/sharp
 links gebogen, spitz/spitz
 curvada a la izquierda, aguda/aguda
 coudée à gauche, pointue/pointue
 curvata a sinistra, acuta/acuta



18-981-07 4.0 mm x 0.8 mm

x = 7.5 cm - 3"
 straight, sharp/blunt
 gerade, spitz/stumpf
 recta, aguda/roma
 droit, pointue/mousse
 retta, acuta/smussa

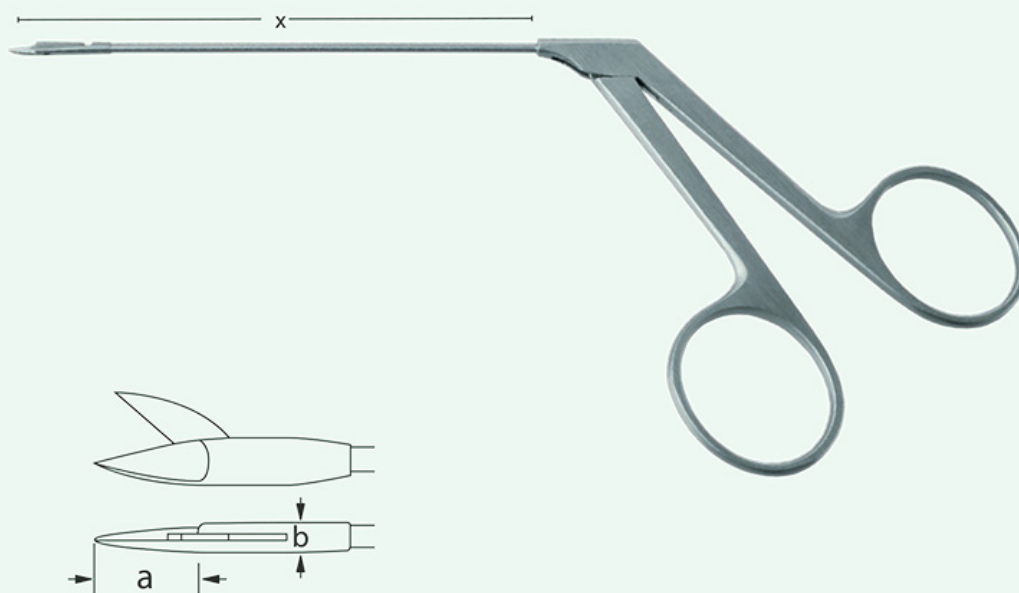

Wullstein

18-982-08

x = 8 cm - 3 1/4"

a x b

straight, sharp/sharp
gerade, spitz/spitz
recta, aguda/aguda
droit, pointue/pointue
retta, acuta/acuta



18-983-08

4.0 mm x 0.8 mm

x = 8 cm - 3 1/4"

curved upwards, sharp/sharp
aufgebogen, spitz/spitz
curvada arriba, aguda/aguda
coudée en haut, pointue/pointue
curvata in alto, acuta/acuta



Wullstein

18-984-08

x = 8 cm - 3 1/4"

a x b

curved to right, sharp/sharp
rechts gebogen, spitz/spitz
curvada a la derecha, aguda/aguda
coudé à droite, pointue/pointue
curvata a destra, acuta/acuta



18-985-08

4.0 mm x 0.8 mm

x = 8 cm - 3 1/4"

curved to left, sharp/sharp
links gebogen, spitz/spitz
curvado a la izquierda, aguda/aguda
coudée à gauche, pointue/pointue
curvata a sinistra, acuta/acuta



Plester

18-986-16

Wireguide
 Führungsgabel
 Tenedor guía
 Fourchette d'introduction
 Forchetta guida



18-987-16

Raspatory
 Raspatorium
 Raspatorio
 Rugine
 Raspatorio



18-988-16

16 cm - 6 1/4"

Elevator
 Elevatorium
 Elevador
 Élévateur
 Elevatorio



18-989-00

1.8 mm
 Raspatory
 Raspatorium
 Raspatorio
 Rugine
 Raspatorio



18-990-00

1.0 mm
 Raspatory
 Raspatorium
 Raspatorio
 Rugine
 Raspatorio



18-991-00

Dissector, double curved left
 Dissektor, doppelt links gebogen
 Dissector, doble curvado a la izquierda
 Dissecteur, double courbe à gauche
 Dissettore doppio curvato a sinistra



18-992-16

Dissector, double curved right
 Dissektor, doppelt rechts gebogen
 Dissector, doble curvado a la derecha
 Dissecteur, double courbe à droite
 Dissettore, doppio curvato a destra



18-993-16 16 cm - 6 1/4"

Instrument for placing wire prothesis
 Handinstrument zum Andrücken von Drahtprothesen
 Instrumento para posicionar protésis de alambre
 Instrument pour mettre en place des protheses en fils métalliques
 Strumento per posizionare prothesi di fili metallici



House

18-994-01	3.5 mm
18-994-02	4.0 mm
18-994-03	4.5 mm
18-994-05	5.0 mm

16 cm - 6 1/4"
 Measuring rod
 Messsonde
 Sonda para medir
 Sonde à mesurer
 Sonda per misurare



Rosen

18-995-16

1.5 mm Ø - 90°

Circular cutting knife
Rundschnittmesser
Cuchillo redondo
Couteau rond
Coltello rotondo



18-996-16

45°

Tympanum knife
Trommelfellmesser
Cuchillo para el timpano
Couteau pour le tympan
Coltello per timpani



18-997-16

45°

Lancet knife
Lanzenmesser
Cuchillo lanceolado
Couteau lancéolaire
Coltello lancelato



18-998-16

16 cm - 6 ¼"

Lancet knife
Lanzenmesser
Cuchillo lanceolado
Couteau lancéolaire
Coltello lancelato



Schuhknecht

18-999-16

Rollerknife, parallel
Rollermesser, paralell
Cuchillo redondo, vertical
Couteau à lame,
tournante, verticale
Coltello rotondo, parallelo



18-100-16 16 cm - 6 ¼"

Rollerknife, right angled
Rollermesser, rechtwinklig
Cuchillo redondo, horizontal
Couteau à lame,
tournante, horizontale
Coltello rotondo, orizzontale



18-101-00

Sickle knife,
slightly curved
Sichelmesser,
leicht gebogen
Cuchillo de hoz,
ligeramente curvado
Couteau faucille,
légèrement courbe
Coltello a ferma di falce,
legermente curvo



18-102-00

Discision knife,
straight
Diszisionsmesser,
gerade
Cuchillo de discisión,
recto
Couteau à discision,
droit
Coltello di dissezione,
retto



Plester

18-103-16 16 cm - 6 ¼"

Flap knife
Lappenmesser
Cuchillo para lobulos
Couteau à lambeaux
Coltello per stacchi



18-104-01 3.0 mm Ø

18-104-02 2.6 mm Ø

18-104-03 2.0 mm Ø

18-104-04 1.5 mm Ø

18-104-05 1.0 mm Ø

16 cm - 6 ¼"

45°

Circular cutting knife
Rundschnittmesser
Cuchillo redondo
Couteau rond
Coltello rotondo



Zöllner

18-105-16

1 mm
Raspatory
Raspatorium
Raspatorio
Rugine
Raspatorio



18-106-16 16 cm - 6 ¼"

1 mm
Raspatory
Raspatorium
Raspatorio
Rugine
Raspatorio



Zöllner

18-107-00 13 cm - 5"

90°
 Roundknife, angled up
 Rundschnittmesser, nach oben gebogen
 Cuchillo redondo, angulado arriba
 Coureau rond, coudé en haut
 Coltello rotondo, angolato in alto



18-108-00 13 cm - 5"

90°
 Roundknife, angled down
 Rundschnittmesser, nach unten gebogen
 Cuchillo redondo, angulado a bajo
 Coureau rond, coudé en bas
 Coltello rotondo, angolato in basso



18-109-00 13 cm - 5"

Sickleknife, angled up
 Sichelmesser, nach oben gebogen
 Cuchillo de hoz, angulado arriba
 Coureau faucille, courbe vers le haut
 Coltello a forma di falce, angolato in alto



18-110-00 13 cm - 5"

Sickleknife, angled down
 Sichelmesser, nach unten gebogen
 Cuchillo de hoz, angulado a bajo
 Coureau faucille, courbe vers le bas
 Coltello a forma di falce, curvato in basso



18-111-00 13 cm - 5"

Lancetknife, curved to left
 Lanzenmesser, links gebogen
 Cuchillo lanceolado, angulado a la izquierda
 Coureau lancéolaire, courbe à gauche
 Coltello lancelato, curvato a sinistra



18-112-00 13 cm - 5"

Lancetknife, curved to right
 Lanzenmesser, rechts gebogen
 Cuchillo lanceolado, angulado a la derecha
 Coureau lancéolaire, courbe à droite
 Coltello lancelato, curvato a destra



18-113-00 13 cm - 5"

Raspatory, curved to left
 Raspatorium, links gebogen
 Raspatorio, angulado a la izquierda
 Décolleur, courbe à gauche
 Raspatorio, curvato a sinistra



18-114-00 13 cm - 5"

Raspatory, curved to right
 Raspatorium, rechts gebogen
 Raspatorio, angulado a la derecha
 Décolleur, courbe à droite
 Raspatorio, curvato a destra



18-115-00 13 cm - 5"

Wire guide
 Führungsgabel
 Tenedor guía
 Fourchette d'introduction
 Forchetta guida



Zöllner

18-116-00 13 cm - 5"

Needlefine, straight, sharp
Nadel fein, gerade, spitz
Aguja fina, recta, aguda
Aiguille fine, droite, pointue
Ago fino, retto, acuto



18-117-00 13 cm - 5"

0.5 mm - 90°
Hook, angled up
Häkchen, nach oben gebogen
Gancho, curvado arriba
Crochet, coudé en haut
Uncino, curvato in alto



18-118-00 13 cm - 5"

0.5 mm - 45°
Hook, angled down
Häkchen, nach unten gebogen
Gancho, curvado a bajo
Crochet, coudé en bas
Uncino, curvato in basso



18-119-00 13 cm - 5"

0.5 mm - 90°
Hook, angled up
Häkchen, nach oben gebogen
Gancho, curvado arriba
Crochet, coudé en haut
Uncino, curvato in alto



18-120-00 13 cm - 5"

0.5 mm - 90°
Hook, angled down
Häkchen, nach unten gebogen
Gancho, curvado a bajo
Crochet, coudé en bas
Uncino, curvato in basso



18-121-00 13 cm - 5"

1.0 mm - 45°
Hook, angled up
Häkchen, nach oben gebogen
Gancho, curvado arriba
Crochet, coudé en haut
Uncino, curvato in alto



18-122-00 13 cm - 5"

1.0 mm - 45°
Hook, angled down
Häkchen, nach unten gebogen
Gancho, curvado a bajo
Crochet, coudé en bas
Uncino, curvato in basso



18-123-00 13 cm - 5"

1.0 mm
Hook, curved up
Häkchen, rund nach oben gebogen
Gancho, redondo, curvado arriba
Crochet, courbure rond vers le haut
Uncino, rotondo, curvato in alto



18-124-00 13 cm - 5"

1.0 mm
Hook, curved down
Häkchen, rund nach unten gebogen
Gancho, redondo, curvado a bajo
Crochet, courbure rond ver le bas
Uncino, rotondo, curvato in basso



18-125-16

16 cm - 6 1/4"
 Needle fine, straight, sharp
 Nadel fein, gerade, spitz
 Aguja fina, recta, aguda
 Aiguille fine, droite, pointue
 Ago fino, retto, acuto

18-126-16

16 cm - 6 1/4"
 Needle, slightly curved, sharp
 Nadel, leicht gebogen, spitz
 Aguja, ligeramente curva, aguda
 Aiguille, légèrement courbe, pointue
 Ago, legeremente curvato, acuto

18-127-16

16 cm - 6 1/4"
 Needle, strong curved, sharp
 Nadel, stark gebogen, spitz
 Aguja, muy curvada, aguda
 Aiguille, très courbe, pointue
 Ago, fortemente curvato, acuto

Shambaugh

18-128-01	18-129-01	0.4 mm
18-128-02	18-129-02	0.6 mm
18-128-03	18-129-03	0.8 mm
18-128-04	18-129-04	1.0 mm

45°
 16 cm - 6 1/4"
 Hook, angled
 Häkchen, abgewinkelt
 Gancho, acodado
 Crochet, coudé
 Uncino, angolato

90°

18-130-01	1.0 mm
18-130-02	2.5 mm

16 cm - 6 1/4"
 Hook, retrograd
 Häkchen, retrograd gebogen
 Gancho, acodado, retrogrado
 Crochet, courbe retrograde
 Uncino, curvato reterogrado

18-131-16	16 cm - 6 1/4"
------------------	----------------

0.6 mm
 Hook, retrograd
 Häkchen, retrograd gebogen
 Gancho, acodado, retrogrado
 Crochet, courbe retrograde
 Uncino, curvato reterogrado



Plester

18-135-00 0.4 mm - 90°

16 cm - 6 1/4"
 Foot plate hook, angled, blunt
 Fussplattenhäkchen, abgewinkelt, stumpf
 Gancho, para placa de aido, romo
 Crochet pour la platine de l'étrier, mousse
 Uncino per placca di piede, smusso



Plester

18-136-00 0.4 mm - 45°

16 cm - 6 1/4"
 Antrum hook, angled, blunt
 Antrum Häkchen, aufgewinkelt, stumpf
 Gancho para el antrum, acodado, romo
 Crochet pour l'antré, coudé, mousse
 Uncino per antrum, angolato in alto, smusso

Barbara

18-132-00
 16 cm - 6 1/4"
 sharp/straight
 spitz/gerade
 aguda/recta
 pointue/droite
 acuto/retta

18-133-00
 16 cm - 6 1/4"
 blunt/angled
 stumpf/gewinkelt
 roma/angulada
 mousse/coudée
 smusso/angolato

18-134-00
 16 cm - 6 1/4"
 sharp/curved
 spitz/gebogen
 aguda/curva
 pointue/courbe
 acuto/curve



Shambaugh

18-137-01

18-137-02

18-137-03

16 cm - 6 ¼"
90°

Hook, curved up
Häkchen, nach oben gebogen
Gancho, curvado arriba
Crochet, coudé en haut
Uncino, curvato in alto

18-138-01 0.3 mm

18-138-02 0.6 mm

18-138-03 1.0 mm

16 cm - 6 ¼"
90°

Hook, curved down
Häkchen, nach unten gebogen
Gancho, curvado a bajo
Crochet, coudé en bas
Uncino, curvato in basso

McGee

18-139-01

18-139-02

18-139-03

16 cm - 6 ¼"

Hook, round, curved up
Häkchen, rund, nach oben gebogen
Gancho, redondo, curvado arriba
Crochet, courbé ronde, vers le haut
Uncino, rotondo, curvato in alto

18-140-01 0.3 mm

18-140-02 0.6 mm

18-140-03 1.0 mm

16 cm - 6 ¼"

Hook, round, curved down
Häkchen, rund, nach unten gebogen
Gancho, redondo, curvado arriba
Crochet, courbé ronde vers le bas
Uncino, rotondo, curvato in basso

Barbara

18-141-15 15.5 mm - 6"

0.5 mm

Rosen

18-142-16 16 cm - 6"

0.5 mm

Needle, slightly curved
Nadel, leicht gebogen
Aguja, ligeramente, curvado
Aiguille, légèrement courbée
Ago, legermente curvato

McGee

18-143-01

18-143-02

18-143-03

16 cm - 6 ¼"
25°

Hook, curved up
Häkchen, nach oben gebogen
Gancho, curvado arriba
Crochet, coudé en haut
Uncino, curvato in alto

McGee

18-144-01

18-144-02

18-144-03

16 cm - 6 ¼"
25°

Hook, curved down
Häkchen, nach unten gebogen
Gancho, curvado a bajo
Crochet, coudé en bas
Uncino, curvato in basso

McGee

18-145-01

18-145-02

18-145-03

16 cm - 6 ¼"
45°

Hook, curved up
Häkchen, nach oben gebogen
Gancho, curvado arriba
Crochet, coudé en haut
Uncino, curvato in alto

McGee

18-146-01 0.3 mm

18-146-02 0.6 mm

18-146-03 1.0 mm

16 cm - 6 ¼"
45°

Hook, curved
Häkchen, nach unten gebogen
Gancho, curvado a bajo
Crochet, coudé en bas
Uncino, curvato in basso



Fisch

18-147-15

15.5 cm - 6"
 angled to the right
 rechts abgewinkelt
 angulado por la derecha
 coudé à droite
 angulato a destra



18-148-15

15.5 cm - 6"
 angled to the left
 links abgewinkelt
 angulado por la izquierda
 coudé à gauche
 angulato a sinistra



18-149-15

15.5 cm - 6"
 angled to the right
 rechts abgewinkelt
 angulado por la derecha
 coudé à droite
 angulato a destra



18-150-15

15.5 cm - 6"
 angled to the left
 links abgewinkelt
 angulado por la izquierda
 coudé à gauche
 angulato a sinistra

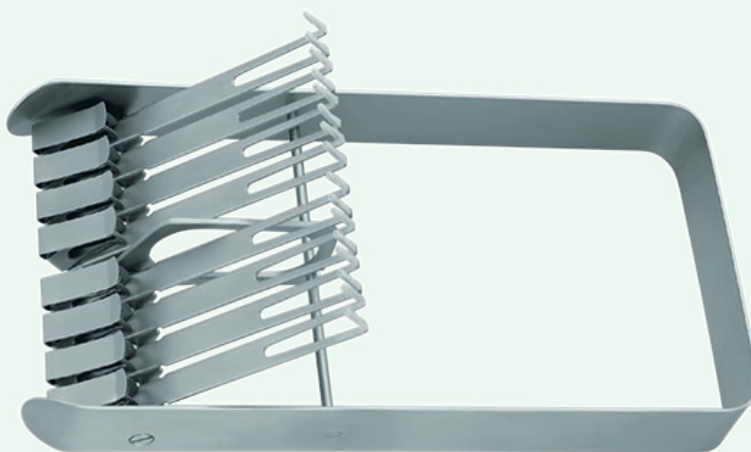

Bekko

18-151-00

Rack for 8 each micro ear instruments with hexagonal or octagonal handle
 Rack für 8 Mikro-Ohr-Instrumente mit Sechs- oder Achtkantgriff
 Soporte para 8 micro-instrumentos con mangos hexagonales o octagonales
 Etagère pour 8 micro-instruments avec manches hexagonales ou octagonales
 Supporto per 8 strumenti micro con manico esagonale e ottagonale



House

18-152-17 17 cm - 6 3/4"

Spoon, strong curved
Löffel, stark gebogen
Cureta, muy curvada
Curette, fortement coudée
Cucchaio, fortemente curvato

18-153-17 17 cm - 6 3/4"

Spoon, slightly curves
Löffel, leicht gebogen
Cureta, ligeramente curvada
Curette, légèrement coudée
Cucchaio, legeremente curvato



Shea

18-154-16

16 cm - 6 1/4"
straight
gerade
recta
droits
retto



18-155-00 1.5 mm x 2.5 mm

curved
gebogen
curva
courbe
curvo



House

18-160-15

1.0mm Ø and 1.2mm Ø
 Spoon, slightly curved
 Löffel, leicht gebogen
 Cureta, ligeramente curvada
 Curette, légèrement coudée
 Cucchiaio, legeremente curvato

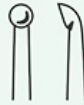

House

18-156-15 15 cm - 6"

1.0 mm Ø and 1.2 mm Ø
 Spoon strong curved
 Löffel stark gebogen
 Cureta, muy curvada
 Curette fortement coudée
 Cucchiaio, fortemente curvato

House

18-158-15 15 cm - 6"

1.0 mm Ø and 1.2 mm Ø



18-157-15 15 cm - 6"

1.5 mm Ø and 1.8 mm Ø
 Spoon strong curves
 Löffel stark gebogen
 Cureta, muy curvada
 Curette fortement coudée
 Cucchiaio, fortemente curvato

18-159-15 15 cm - 6"

1.5 mm Ø and 1.8 mm Ø



18-161-15 15 cm - 6"

1.5mm Ø and 1.8 mm Ø
 Spoon, slightly curves
 Löffel, leicht gebogen
 Cureta, ligeramente curvada
 Curette, légèrement coudée
 Cucchiaio, legeremente curvato

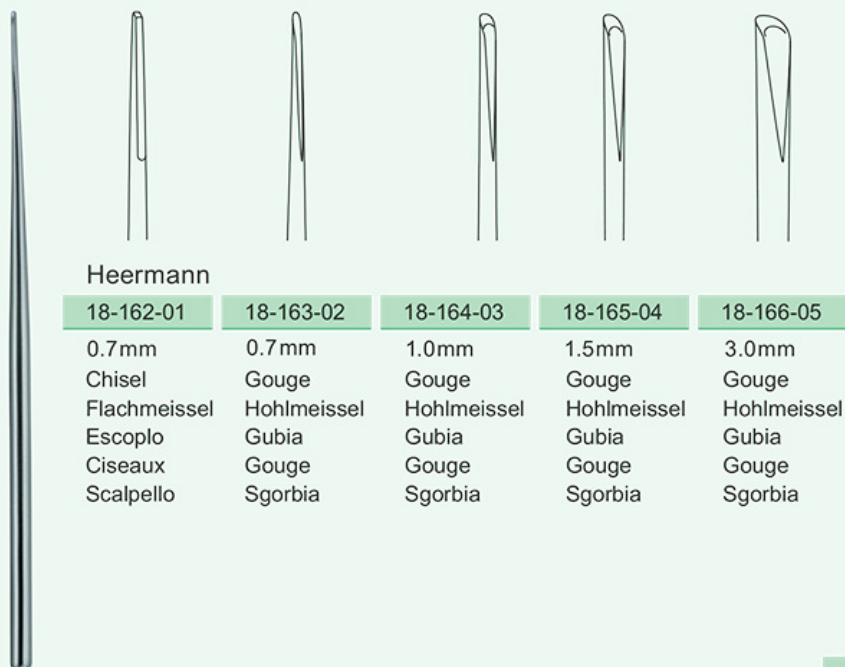

Heermann

18-162-01	18-163-02	18-164-03	18-165-04	18-166-05
0.7mm	0.7mm	1.0mm	1.5mm	3.0mm
Chisel	Gouge	Gouge	Gouge	Gouge
Flachmeißel	Hohlmeißel	Hohlmeißel	Hohlmeißel	Hohlmeißel
Escoplo	Gubia	Gubia	Gubia	Gubia
Ciseaux	Gouge	Gouge	Gouge	Gouge
Scalpello	Sgorbia	Sgorbia	Sgorbia	Sgorbia



Heermann

18-167-00

Handle for chisels
Handgriff für Meißel
Mango para escoplos
Manche pour ciseaux
Manico per scalpelli/sgorbie



Heermann

18-168-19 19.5 cm - 7 ¾"

Metal hammer
Hammer, Metall
Martillo, de metal
Maillet en métal
Martello, acciaio



Cottle

18-169-19 19 cm - 7 ½"

250 g
Metal hammer
Hammer, Metall
Martillo, de metal
Maillet en métal
Martello, acciaio



Wullstein

18-170-16

16 cm - 6 1/4"
 straight
 gerade
 recta
 droite
 rette

18-171-16

16 cm - 6 1/4"
 curved
 gebogen
 curva
 courbe
 curvo



Rosen
 Fig. 1

18-172-17

2.5 mm
 bayonet shaped
 bajonettförmig
 en forma de bayoneta
 en forme de baionette
 forma a baionetta



Fig. 2

18-173-17

17.5 cm - 7"
 1.5 mm
 bayonet shaped
 bajonettförmig
 en forma de bayoneta
 en forme de baionette
 forma a baionetta



Lempert

18-174-16

3.0 mm

16 cm - 6 1/4"



Citelli

- 18-175-17 17 cm - 6 3/4"
x = 60mm
1.5mm
- 18-176-17 17 cm - 6 3/4"
2.2 mm
- 18-177-17 17 cm - 6 3/4"
3.0 mm



Kerrison

- | | | | | |
|------------|-----------|-----------|-----------|----------|
| 18-178-20 | 18-179-20 | 18-180-20 | 18-181-20 | x = 80mm |
| 3 x 3mm | 4 x 4 mm | 5 x 5mm | 6 x 6 mm | |
| 20 cm - 8" | | | | |



Beyer
18-182-14 14 cm - 5 ½"
1 mm



Beyer
18-183-19 19 cm - 7 ½"
2 mm



Fig. 1

Fig. 2

Fig. 3

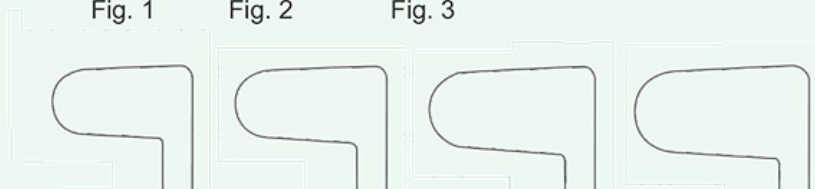

Fig. 4

Fig. 5

Fig. 6

Fig. 7

**Thudichum
(Mark Hovell)**

18-328-01	Fig. 1	8.5x6 mm
18-328-02	Fig. 2	9.0x7 mm
18-328-03	Fig. 3	12.5x8 mm
18-328-04	Fig. 4	15x8.5 mm
18-328-05	Fig. 5	16.5x9 mm
18-328-06	Fig. 6	18x10 mm
18-328-07	Fig. 7	19.5x10.5 mm

18-328-00

Set of 7 pcs. Fig. 1 - 7

**Thudichum
(Mark Hovell)**

18-329-01	Fig. 1	8.5x6 mm
18-329-02	Fig. 2	9.0x7 mm
18-329-03	Fig. 3	12.5x8 mm
18-329-04	Fig. 4	15x8.5 mm
18-329-05	Fig. 5	16.5x9 mm
18-329-06	Fig. 6	18x10 mm
18-329-07	Fig. 7	19.5x10.5 mm

Insulated

18-329-00

Set of 7 pcs. Fig. 1 - 7



**Thudichum
(Goldsmith)**

18-236-06

21 mm x 9.5 mm

18-237-06

21 mm x 10.5 mm

18-238-06

6.5 cm - 2 1/4"

21 mm x 11.5 mm

18-236-00

Set of 3 pcs.

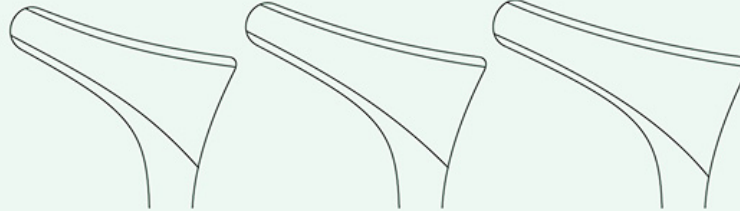

Hartmann

18-239-16

Fig. 1

18-240-16

Fig. 2

18-241-16

16 cm - 6 ¼"

Fig. 3

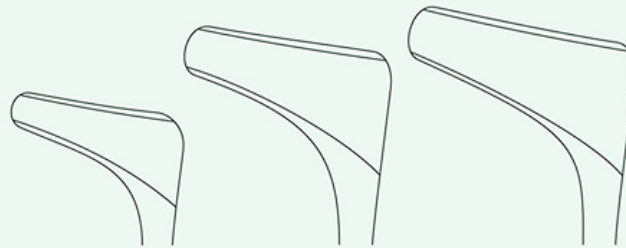

Hartmann-Halle

18-242-15

Fig. 1

18-243-15

Fig. 2

18-244-15

15 cm - 6"

Fig. 3



Tieck-Halle

18-245-13 13.5 cm - 5 ¼"

for babies
 für Säuglinge
 para lactantes
 pour nourrissons
 per lattanti

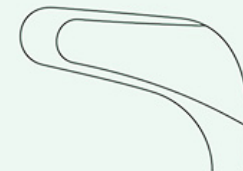

Schwarz

18-246-14 14 cm - 5 ¼"



Killian

18-247-13

x = 35 mm

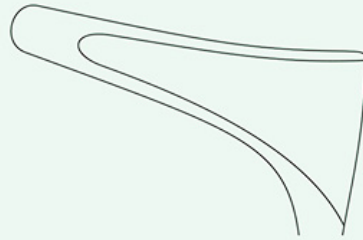

18-248-13 13 cm - 5"

x = 50 mm

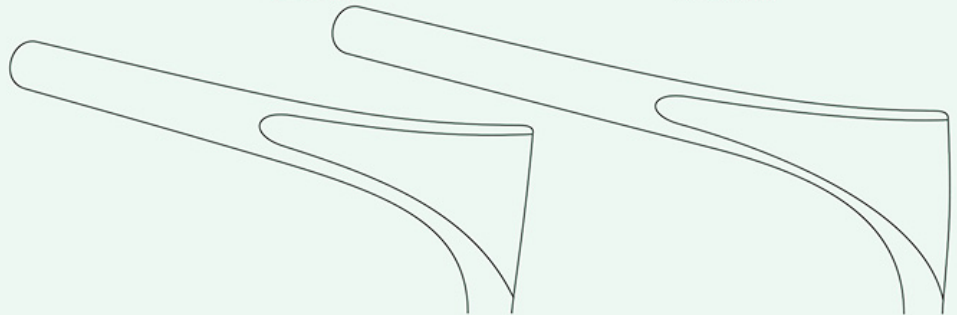

18-249-13

x = 75 mm

18-250-13 13 cm - 5"

x = 90 mm

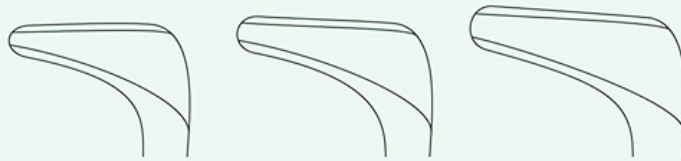

Beckmann

18-251-15

Fig. 1

18-252-15

Fig. 2

18-253-15 15 cm - 6"

Fig. 3

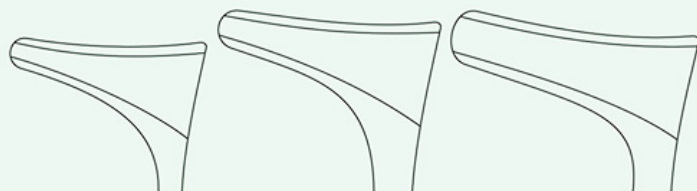

Mod. Wien

18-254-14

Fig. 1

18-255-14

Fig. 2

18-256-14 14.5 cm - 5 ¾"

Fig. 3

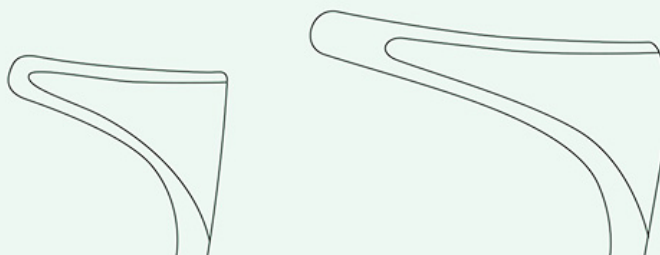

Cottle

18-257-15

x = 35 mm

18-258-15

15 cm - 6"

x = 50 mm

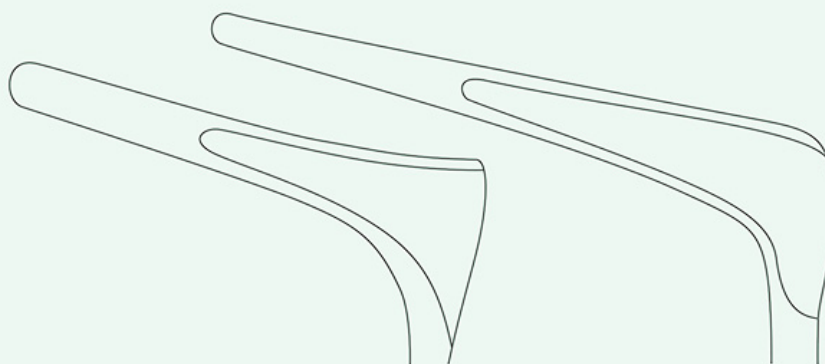

18-259-15

x = 75 mm

18-260-15

15 cm - 6"

x = 90 mm

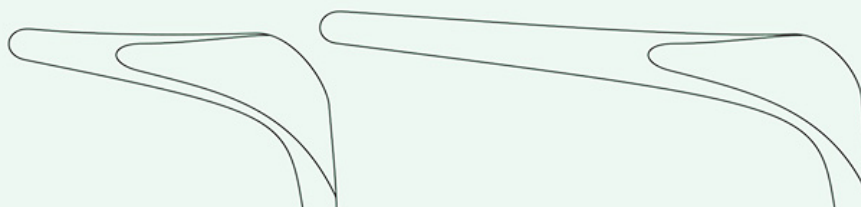

Cottle

18-261-14B

x = 45 mm

black, chrome plated

schwarz verchromt

chromado en negro

chromé en noir

cromato nero

18-262-14B

14 cm - 5 ½"

x = 75 mm



Westmacott

18-263-20 20 cm - 8"



Lubet-Barbon

18-264-20 20 cm - 8"



Hartmann

18-265-16 16 cm - 6 ¼"

18-265-20 20 cm - 8"



Tilley

18-266-14 14 cm - 5 ½"



Heymann-Knight

18-267-18 18 cm - 7"



Craig

18-268-18 18 cm - 7"

Nasal cutting forceps
 Scharfe Nasenzangen
 Pinzas nasales cortantes
 Pincas coupantes pour le nez
 Nasale taglio forcipe

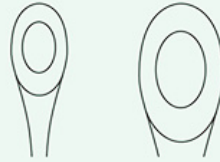

Luc

18-275-20

Fig. 1

18-276-20

Fig. 2

20 cm - 8"

fenestrated
 gefenstert
 fenestrado
 fenêtré
 finestrato

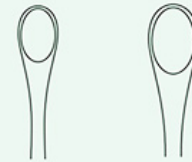

18-277-01

Fig. 1

18-278-02

Fig. 2

plaine
 voll
 lleno
 pleine
 pieno



Takahashi

18-279-12

3.5 mm x 10 mm



18-280-12

3.5 mm x 10 mm

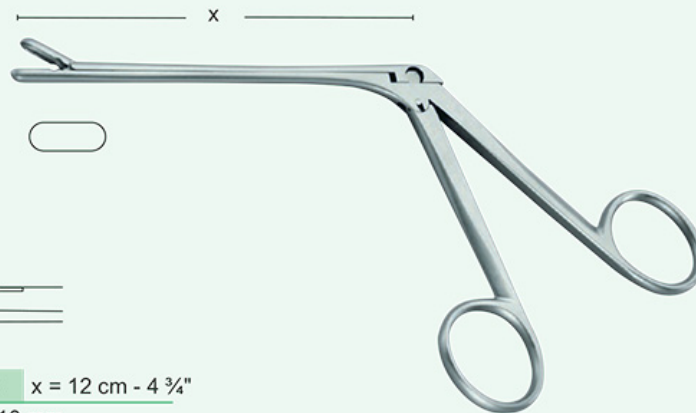

x = 12 cm - 4 3/4"

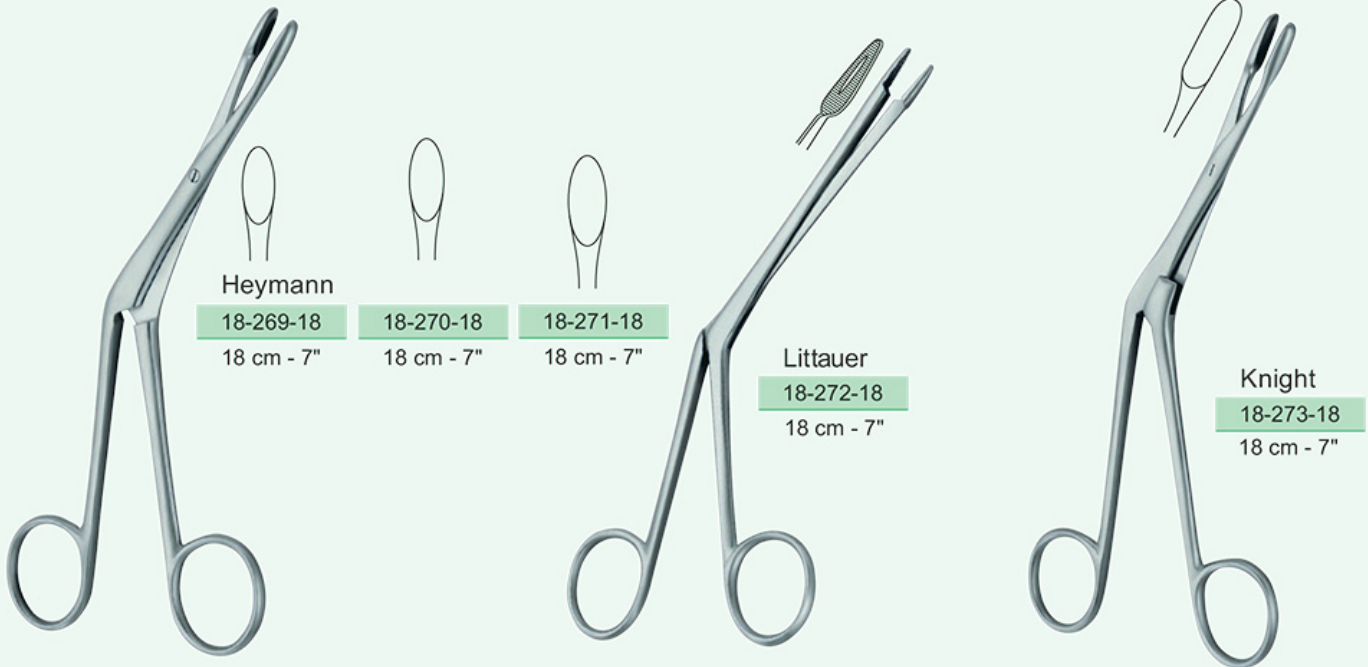

Nasal dressing forceps
Nasentamponzange
Pinza nasale para tamponiamento
Pince à pansement pour le nez
Pinza per tamponamento nasale

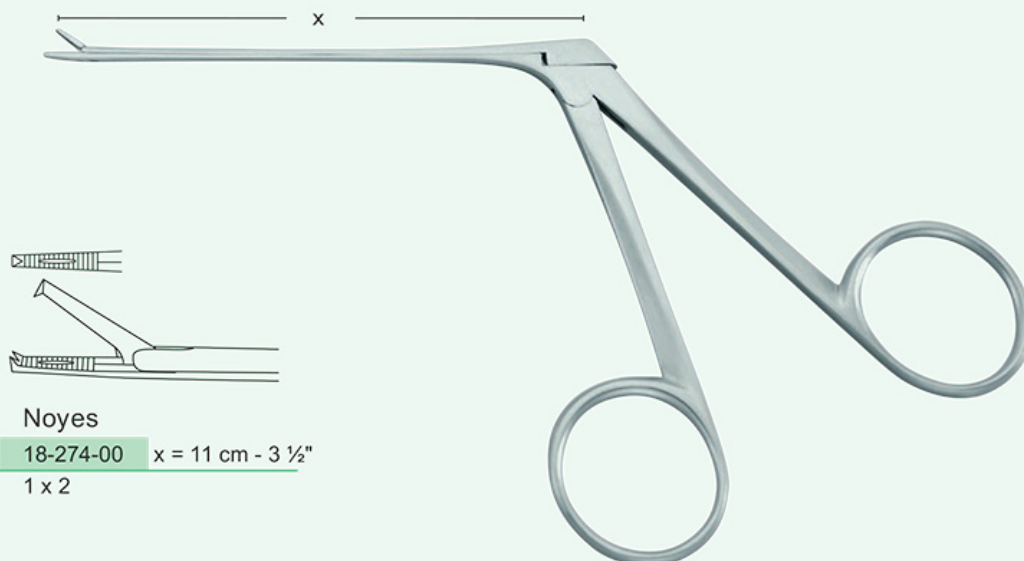

Nasal cutting forceps
 Scharfe Nasenzangen
 Pinzas nasales cortantes
 Pincès coupantes pour le nez
 Nasale taglio forcipe



Bruenings

18-281-19

18-282-19

18-283-19

18-284-19

19 cm - 7 1/2"

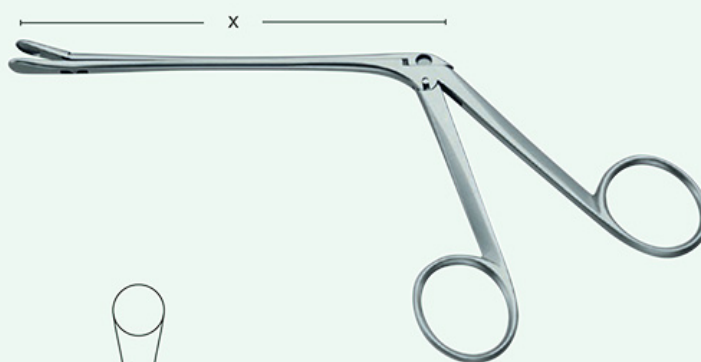

Weil

18-285-12



Watson-Williams

18-286-12



18-287-12

x = 12 cm - 4 3/4"



Fig. 1



Fig. 2



Fig. 3



Fig. 4



Fig. 5

Weil-Blakesley



0°

18-288-12
a = 3.0mm

18-289-12
a = 3.5mm

18-290-12
a = 4.5mm

18-291-12
a = 5.0mm

18-292-12
a = 5.5mm

x = 12 cm - 4 3/4"



45°

18-293-00
a = 3.0mm

18-294-00
a = 3.5mm

18-295-00
a = 4.5mm

18-296-00
a = 5.0mm



90°

18-297-00
a = 3.0mm

18-298-00
a = 3.5mm

18-299-00
a = 4.5mm



45°

Fig. 1
18-300-18
a = 3.0mm

Fig. 2
18-301-18
a = 3.5mm

Fig. 3
18-302-18
a = 4.5mm

Fig. 4
18-303-18
a = 5.0mm

Fig. 5
18-304-18
a = 5.5mm

x = 18 cm - 7"



90°

18-305-18
a = 3.0mm

18-306-18
a = 3.5mm

18-307-18
a = 4.5mm

18-308-18
a = 5.0mm

x = 18 cm - 7"



Hartmann

18-309-12
5mm

18-310-12
7mm

18-311-12
9mm

18-312-12
11mm

x = 12 cm - 4 3/4"

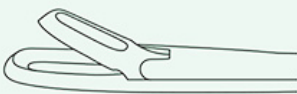

Myles

18-313-12

Fig. 1
2.0x10.0mm

18-314-12

Fig. 2
2.5x12.0mm

18-315-12

Fig. 3
3.0x14.0mm

x = 12 cm - 4 3/4"

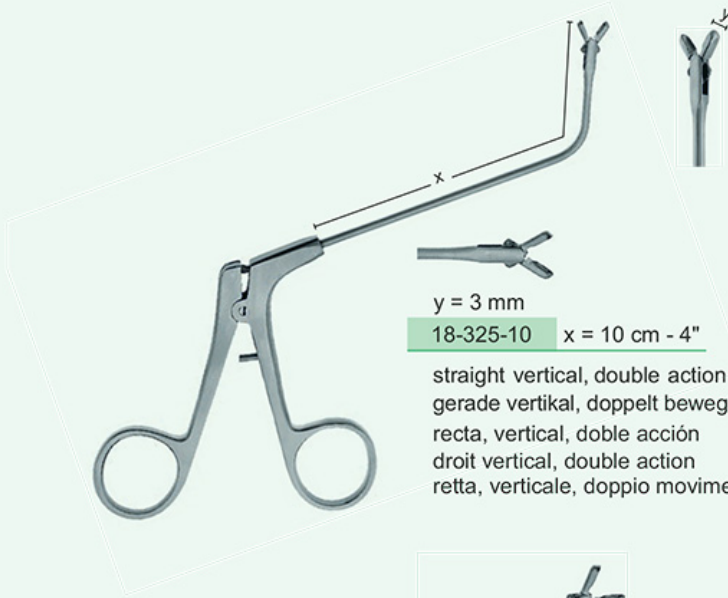

y = 3 mm
18-325-10 x = 10 cm - 4"

straight vertical, double action
 gerade vertikal, doppelt beweglich
 recta, vertical, doble acción
 droit vertical, double action
 retta, verticale, doppio movimento



y = 3 mm
18-326-10 x = 10 cm - 4"

straight hor., double action
 gerade hor., doppelt beweglich
 recta, horizontal, doble acción
 droit horizontal, double action
 retta oriz., doppio movimento

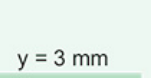

y = 3 mm
18-327-10 x = 10 cm - 4"

straight hor., single action, short
 gerade hor., einfach beweglich, kurz
 recta, hor., acción simple, corto
 droit hor., action simple, court
 retta, oriz., movimento sing., corto



y = 3 mm
18-328-10 x = 10 cm - 4"

45° vertical, double action
 45° vertikal, doppelt beweglich
 45° vertical, doble acción
 45° vertical, double action
 45° verticale, doppio movimento



y = 3 mm
18-329-10 x = 10 cm - 4"

45° hor., double action
 45° hor., doppelt beweglich
 45° hor., doble acción
 45° hor., double action
 45° oriz., doppio movimento



y = 3 mm
18-330-10 x = 10 cm - 4"

45° vert., single action, short
 45° vert., einfach beweglich, kurz
 45° vert., acción simple, corto
 45° vert., action simple, court
 45° vert., movimento sing., corto



y = 3 mm
18-331-10 x = 10 cm - 4"

70° vertical, double action
 70° vertikal, doppelt beweglich
 70° vertical, doble acción
 70° vertical, double action
 70° verticale, doppio movimento



y = 3 mm
18-332-10 x = 10 cm - 4"

70° hor., double action
 70° hor., doppelt beweglich
 70° hor., doble acción
 70° hor., double action
 70° oriz., doppio movimento



y = 3 mm
18-333-10 x = 10 cm - 4"

110° hor., double action
 110° hor., doppelt beweglich
 110° hor., doble acción
 110° hor., double action
 110° oriz., doppio movimento

y = 3 mm
18-334-10 x = 10 cm - 4"

70° vert., single action, short
 70° vert., einfach beweglich, kurz
 70° vert., acción simple, corto
 70° vert., action simple, court
 70° vert., movimiento sing., corto

y = 3 mm
18-335-10 x = 10 cm - 4"

70° hor., single action
 70° hor., einfach beweglich
 70° hor., acción simple, corto
 70° hor., action simple, court
 70° oriz., movimiento sing., corto



y = 4 mm
18-336-10 x = 10 cm - 4"

45° vertical, double action
45° vertikal, doppelt beweglich
45° vertical, doble acción
45° vertical, double action
45° verticale, doppio movimento



y = 4 mm
18-337-10 x = 10 cm - 4"

45° hor., double action, short
45° hor., doppelt beweglich, kurz
45° hor., acción doble, corto
45° hor., double action, court
45° oriz., movimento, corta

y = 4 mm
18-338-10 x = 10 cm - 4"

45° vertical, single action, short
45° vertikal, einfach beweglich, kurz
45° vertical, acción simple, corto
45° vertical, action simple, court
45° verticale, movimento singolo, corta



y = 4 mm
18-339-10 x = 10 cm - 4"

70° vertical, double action
70° vertikal, doppelt beweglich
70° vertical, doble acción
70° vertical, double action
70° verticale, doppio movimento



y = 4 mm
18-340-10 x = 10 cm - 4"

70° hor., double action, short
70° hor., doppelt beweglich, kurz
70° hor., acción doble, corto
70° hor., double action, court
70° oriz., movimento, corta

y = 4 mm
18-341-10 x = 10 cm - 4"

70° vertical, single action, short
70° vertikal, einfach beweglich, kurz
70° vertical, acción simple, corto
70° vertical, action simple, court
70° verticale, movimento singolo, corta

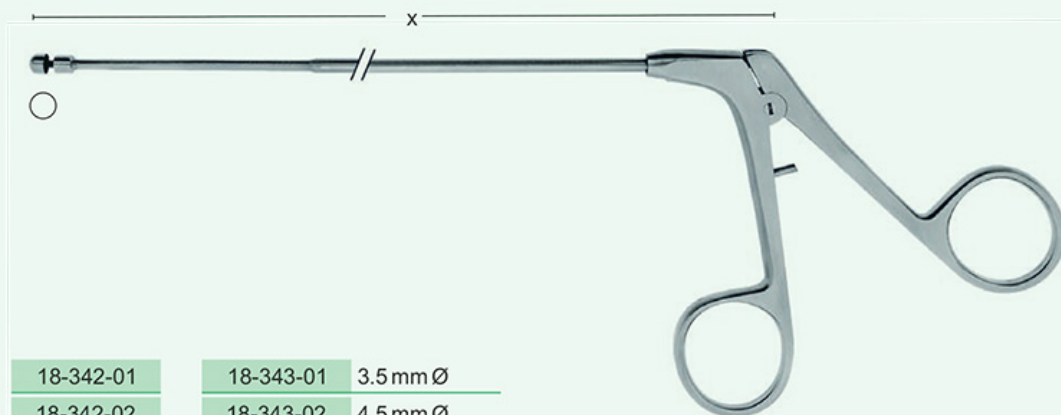

18-342-01

18-343-01

3.5 mm Ø

18-342-02

18-343-02

4.5 mm Ø

x = 180mm – 7"

x = 180mm – 7"

straight

curved upwards

gerade

aufgebogen

recta

curvada arriba

droit

coudé en haut

retta

curvata in alto

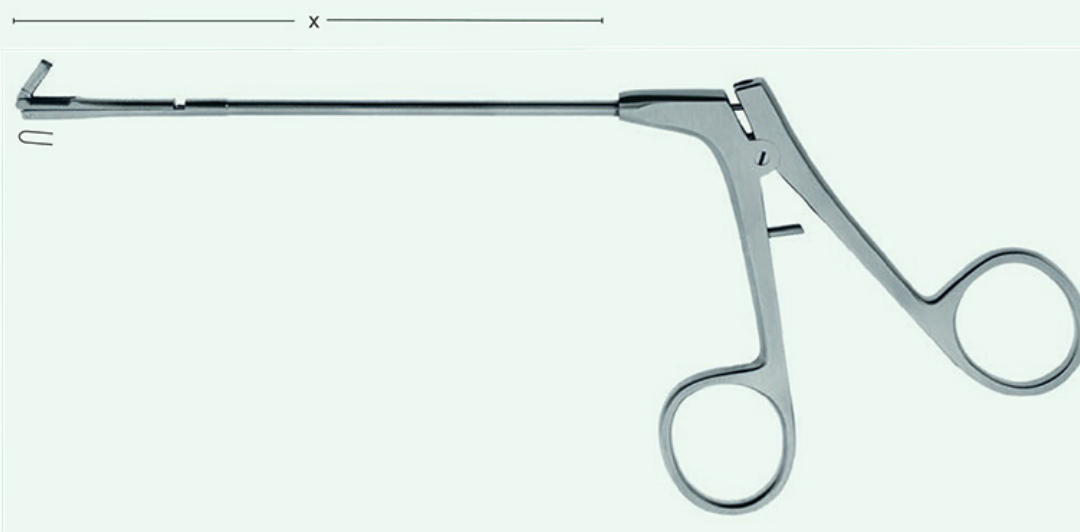

18-344-01

18-345-02

18-346-03

1.5 mm x 4.5 mm

Fig. 1

Fig. 2

Fig. 3

x = 100 mm

backward, up-cutting

rückwärts nach oben schneidend

retrograda corte arriba

retrograde coupe en haut

retrograda tagliente in alto

backward, cut to the right

rückwärts nach rechts schneidend

retrograda corte a la derecha

retrograde coupe à droite

retrograda tagliente a destra

backward, cut to the left

rückwärts nach links schneidend

retrograda corte a la izquierda

retrograde coupe à gauche

retrograda tagliente a sinistra

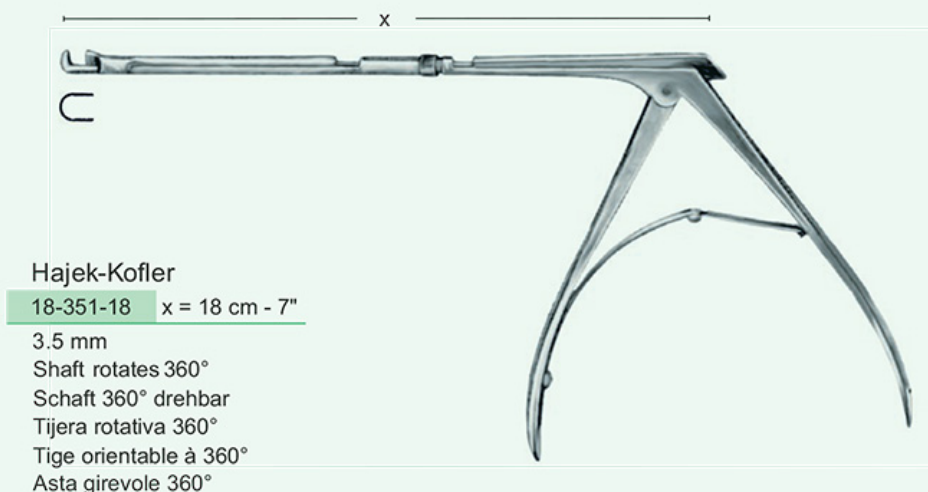

Punches sphenoid bone
 Keilbeinstanzen
 Pinzas para esfenoides
 Pinces pour le sinus sphénoïdal
 Punzoni sfenoide



Hajek-Claus
 18-352-20
 20 mm - 8"



Kerrison

18-353-20	18-354-20	18-355-20	20 mm - 8"
4 mm x 4 mm	5 mm x 5 mm	6 mm x 6 mm	
x = 9 cm - 3 1/2"			



Snare
18-356-00 0.3 mm Ø 100 mm



in bundles of 12 pieces
in Bündeln mit 12 Stück
en liós de 12 piezas
en paquets de 12 pièces
pacchetto di 12 pezzi



Krause
18-357-26 26 cm - 10 ¼"



Krause-Voss
18-358-26 26 cm - 10 ¼"

with 2 inserts
mit 2 Aufsätzen
con 2 guias
avec 2 guide-anses
con 2 guide ansa



Lange-Wilde
18-359-24 24 cm - 9 ½"



Fomon
 18-360-16
 16.5 cm - 6 ½"

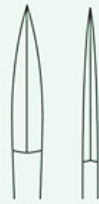

Joseph
 18-361-16
 Fig. 1
 sharp/sharp
 scharf/spitz
 cortante/agudo
 tranchant/pointu
 acuto



18-362-16
 Fig. 2
 straight
 gerade
 recta
 droit
 retto



18-363-16
 Fig. 1



18-364-16 16 cm - 6 ¼"
 Fig. 2
 curved
 gebogen
 curva
 courbe
 curvo



Joseph
 18-365-14
 14 cm - 5 ½"



Cottle
 18-366-15
 15 cm - 6"



Joseph
 18-367-17
 17.5 cm - 7"



Bruenings
 18-368-16
 16.5 cm - 6 ½"

18-369-00
 Spareblade
 Ersatzklinge
 Hoja de recambio
 Lame de rechange
 Lama di ricambio



Freer
18-370-19



18-371-19 19 cm - 6 1/2"



Converse
18-372-16
16 cm - 6 1/4"



Freer
18-373-15
15 cm - 6"



Freer
18-374-15
15 cm - 6"



Freer
18-375-15
15 cm - 6"



Freer
18-376-21



18-377-21 21 cm - 8 ¼"



Bruno
18-378-20
20 cm - 8"
Sickle knife
Sichelmesser
Cuchillo falciforme
Couteau à faucille
Coltello a forma di falce



Bruenings
18-379-23
23 cm - 9"



Abraham
18-380-22
22 cm - 8 ¾"



Fischer
18-381-23
23 cm - 9"

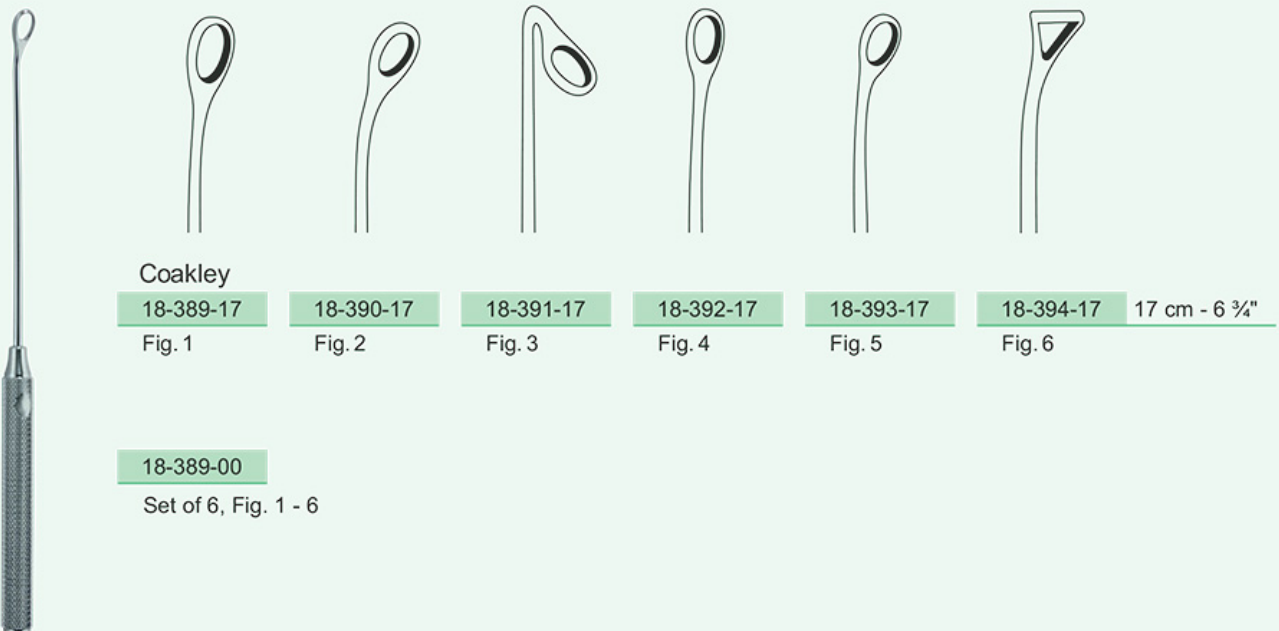
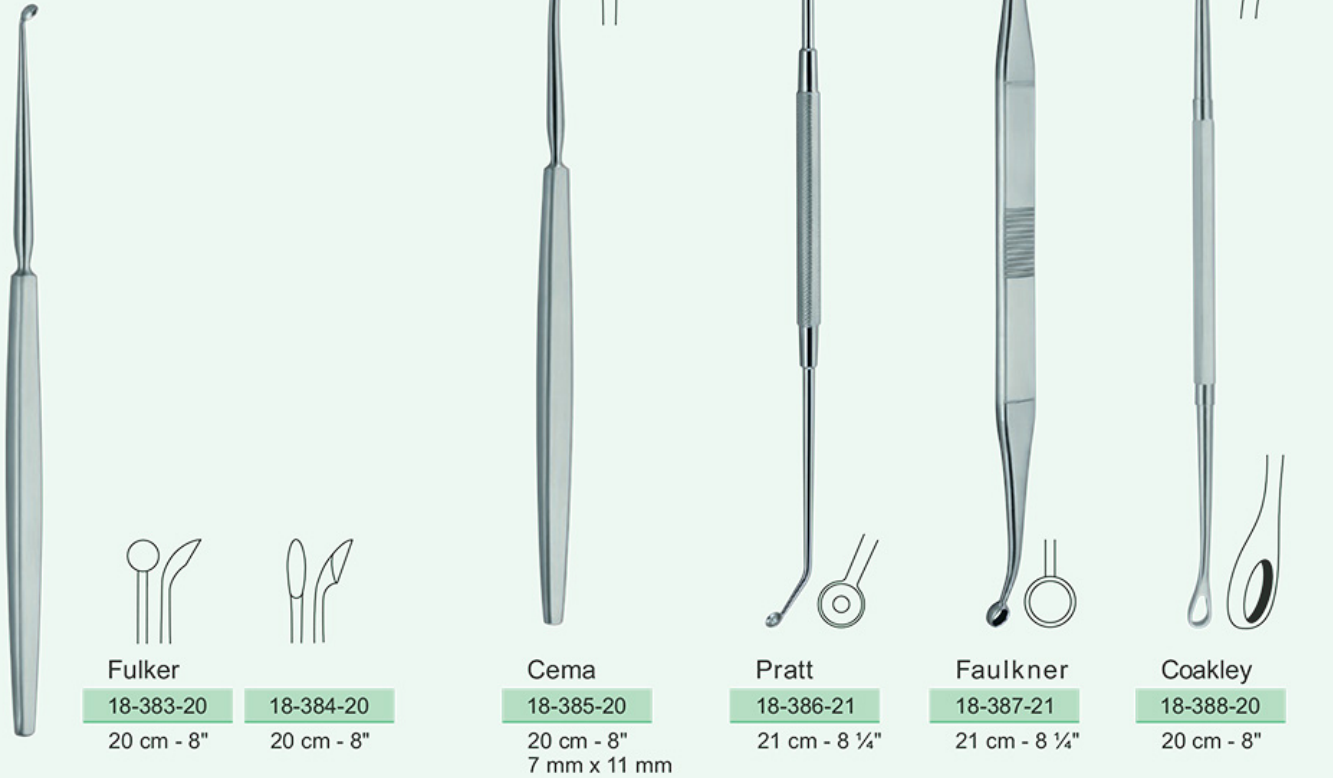

Septum elevators – raspatories
 Septum elevatorien – Raspatorien
 Elevadores – legras para el tabique nasal
 Elevateurs – rugines pour la cloison nasale
 Ascensori setto - Raspatories

surgimax™
 saving lives

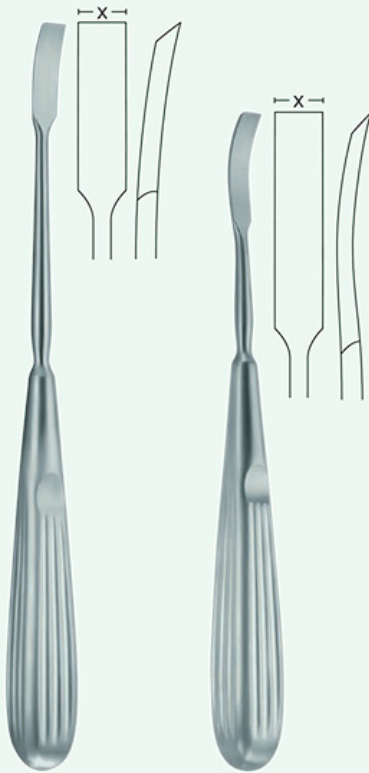

Lempert
 Fig. 1
 18-395-20
 20.5 cm - 8"

Fig. 2
 18-396-18 x = 6 mm
 18 cm - 7"



Freer
 18-397-16 16 cm - 6 ¼"
 x = 4 mm



Cottle
 18-398-19 19 cm - 7 ½"
 x = 8 mm
 sharp
 scharf
 cortante
 tranchant
 acuta



Joseph
 18-399-00
 x = 5 mm
 Periostalelevators
 Periost Elevatorien
 Periostotomo
 Périostotome
 Periostotomo



Sewall
 18-400-20 20 cm - 8"
 Antrum elevator
 Antrum Elevatorium
 Elevador para el antro
 Elévateur pour le fosse nasale
 Elevatore per antro



Halle
 18-401-16
 16 cm - 6 ¼"

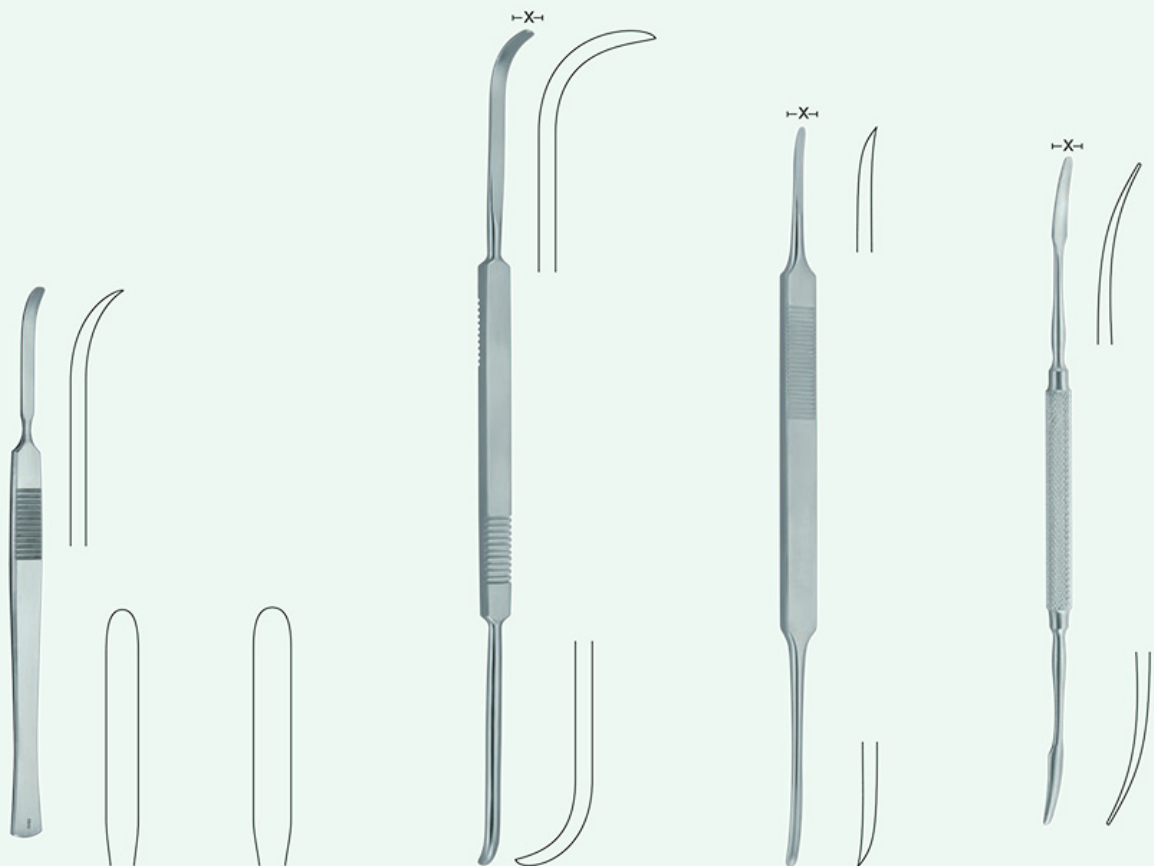

McKenty

18-402-15

15 cm - 6"
4 mm

sharp
scharf
cortante
tranchant
acuta

18-403-15

15 cm - 6"
5 mm

Cottle

18-404-23

23.5 cm - 9 ¼"
x = 5 mm

sharp
scharf
cortante
tranchant
acuta

McKenty

18-405-20

20.5 cm - 8"
x = 4 mm

sharp
scharf
cortante
tranchant
acuta

Killian

18-406-18

18 cm - 7"
x = 4 mm

sharp/blunt
scharf/stumpf
cortante/romo
tranchant/mousse
acuta/smussa

Septum elevators – raspatories
 Septumelevatorien – Raspatorien
 Elevadores – legras para el tabique nasal
 Elevateurs – rugines pour la cloison nasale
 Ascensori setto - Raspatories

surgimax™
 saving lives



Killian
18-407-23
 23 cm - 9"
 x = 4.5 mm
 sharp/blunt
 scharf/stumpf
 cortante/romo
 tranchant/mousse
 acuta/smussa



Freer
18-408-19
 19 cm - 7 ½"
 blunt
 stumpf
 romo
 mousse
 smussa



Freer
18-409-18
 18 cm - 7"
 sharp/blunt
 scharf/stumpf
 cortante/romo
 tranchant/mousse
 acuta/smussa



Freer
18-410-20
 20.5 cm - 8"
 sharp/blunt
 scharf/stumpf
 cortante/romo
 tranchant/mousse
 acuta/smussa

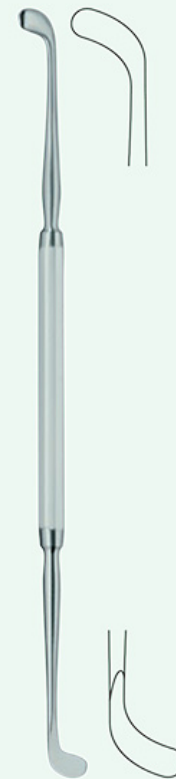

Pennington
18-411-21
 21.5 cm - 8 ½"
 blunt
 stumpf
 romo
 mousse
 smussa



Joseph-Masing
18-412-21
 21.5 cm - 8 ½"
 sharp
 scharf
 cortante
 tranchant
 acuta



Masing

18-413-20 20.8 cm - 8"



Ballenger-Hajek

18-414-19 19 cm - 7 ¼"

18-414-22 22 cm - 8 ¾"



Cottle

18-415-22 22 cm - 8 ¾"



Cottle Modified

18-416-21 21 cm - 8 ¼"





Boies

18-417-19 19 cm - 7 ½"

Nasalfracture elevator, blunt
Nasenfraktur Elevatorium, stumpf
Elevador para fracturas nasales, romas
Elévateur pour fractures nasales, mousse
Elevatore per fratture nasali, smussa



Goldman

18-418-17 17 cm - 6 ¾"

Septum displacer
Septumfraktur Elevatorium
Elevador para fracturas del tabique nasal
Elévateur pour fractures de la cloison nasale
Elevatore per fratture del setto



Joseph

18-421-19

19 cm - 7 ½"



18-422-19

19 cm - 7 ½"



Joseph

18-423-19

19 cm - 7 ½"

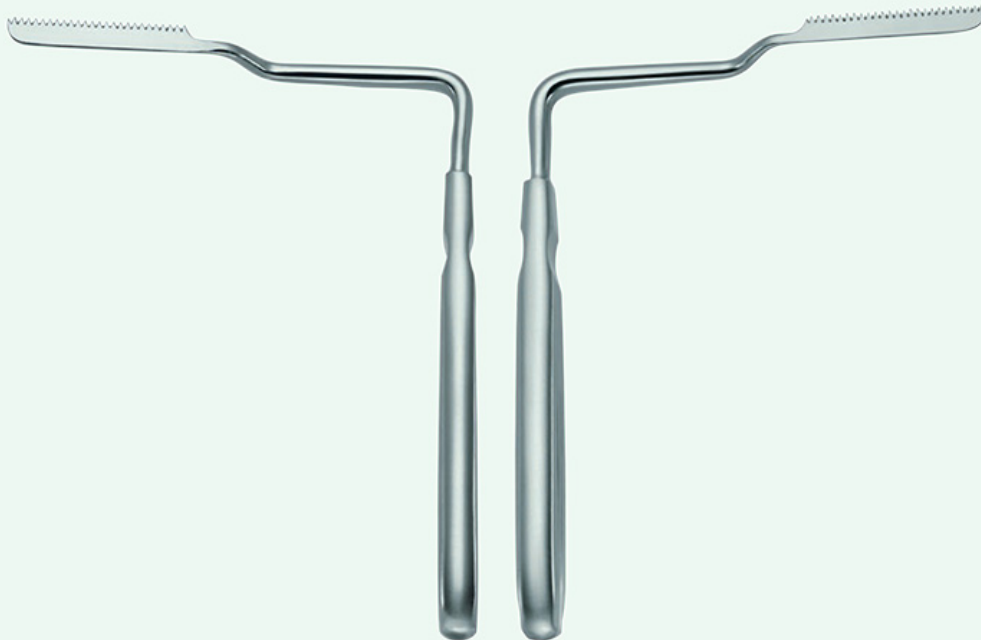

Joseph

18-424-17

17 cm - 7 ½"

18-425-17

17 cm - 7 ½"

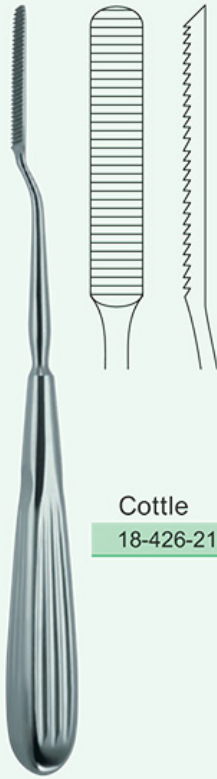

Cottle

18-426-21 21 cm - 8 ¼"



Maltz

18-427-17

17 cm - 6 ¾"
 34 mm x 7 mm

drawing cut
 auf Zug schneidend
 cortante a tracción
 tranchant à traction
 tagliente a trazione



18-428-17

17 cm - 6 ¾"
 34 mm x 7 mm

pushing cut
 auf Stoss schneidend
 cortante a empuje
 tranchant à impact
 tagliente a urto



Aufricht

18-429-21

21 cm - 8 ¼"
 pushing cut
 auf Stoss schneidend
 cortante a empuje
 tranchant à impact
 tagliente a urto



18-430-21

21 cm - 8 ¼"
 drawing cut
 auf Zug schneidend
 cortante a tracción
 tranchant à traction
 tagliente a trazione

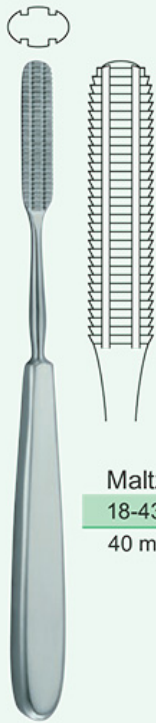

Maltz

18-431-17 17.5 cm - 7"

40 mm x 9 mm



Wiener

18-432-18

3.5 mm Ø

18-433-18

18 cm - 7"

3.5 mm Ø

Antrum rasps
Antrum Raspeln
Limas para el antrum
Râpes pour le fosse nasale
Raspe per antrum



Gallaher

18-434-16

16 cm - 6 ¼"

18-435-16

16 cm - 6 ¼"

18-436-16

16 cm - 6 ¼"



Fomon

18-437-21

21 cm - 8 ¼"

Rasps with tungsten carbide
 Raspeln mit Hartmetall
 Limas con carburo de tungsteno
 Râpes avec inserts de carbure de tungstène
 Raspe con carburo di tungsteno

surgimax™
 saving lives



Fig. 1
 12
 Teeth
 Zähne
 Dientes
 Dentes
 Denti



Fig. 3
 16



Fig. 5
 24



Fig. 7
 36

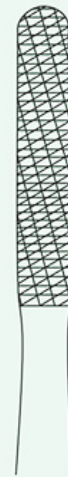

Fig. 9
 52

Fomon

18-443-20T	18-444-20T	18-445-20T	18-446-20T	18-447-20T	20 mm - 8"
18-443-20	18-444-20	18-445-20	18-446-20	18-447-20	20 mm - 8"



Fig. 2
 14
 Teeth
 Zähne
 Dientes
 Dentes
 Denti



Fig. 4
 20



Fig. 6
 30

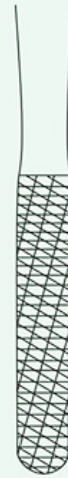

Fig. 8
 44

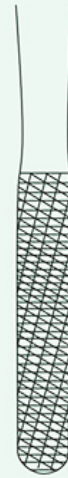

Fig. 10
 62



Bruenings-Brunk

18-448-19 19 cm - 7 ½"

Antrum retractor, serrated
Kieferhöhlenhaken, gezahnt
Separador para sinus, dentado
Ecarteur pour sinus maxillaire, dentelé
Retrattore mascellare, dentato



Ritter-Halle

18-449-01 2.5 mm Ø

18-449-02 3.0 mm Ø

18-449-03 4.0 mm Ø

16 cm - 6 ¼"
Frontal sinus bougies
Stirnhöhlen-Dilatatoren
Dilatadores para el sinus frontal
Dilatateurs pour le sinus frontal
Dilatatore per il seno frontale



Cottle

18-450-12 12 cm - 4 ¾"

Handle
Griff
Mango
Manche
Manico



Luca

18-451-00 7 mm

Guide support for osteotomes
Führungshilfe für Osteotome
Soporte de guía para osteótomos
Support conducteur pour ostéotomes
Supporto di guida per osteotomi



Cottle

18-452-00 65 mm x 30 mm 30 mm

Cartilage crusher
Knorpelquetsche
Machacadora
Pincers-gouge à cartilage
Torchio per cartilagine

Septum forceps
Septumzangen
Pinzas para el tabique nasal
Pinces pour la cloison nasale
setto forcipe

surgimax™
saving lives



Cottle-Walsham

18-453-23

straight
gerade
recta
droit
rette



18-454-23

left
links
izquierda
à gauche
a sinistra



18-455-23 23 cm - 9"

right
rechts
derecha
à droite
a destra

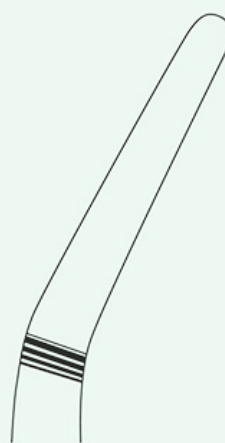

Asch

18-456-23 23 cm - 9"



Middleton-Jansen
18-457-19 19 cm - 7 ½"



Middleton-Jansen
18-458-19 19 cm - 7 ½"



Caplan
18-459-20 20 cm - 8"

toothed
gezahnt
dentado
dentelée
dentato



Rubin
18-460-20 21 cm - 8 ¼"



18-461-00

Protection cap
Schutzkappe
Caperuza protectora
Capuchon protecteur
Calotta protettiva

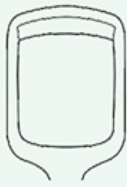

St. Clair-Thomson
 18-462-21

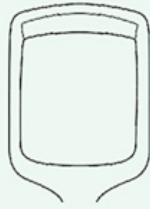

18-463-21



18-464-21



18-465-21 21 cm - 8 ¼"

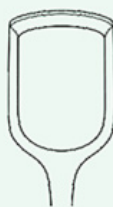

Barnhill
 18-466-22
 Fig. 1

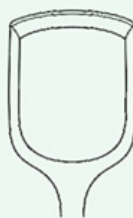

18-467-22
 Fig. 2

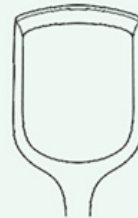

18-468-22
 Fig. 3



18-469-22 22 cm - 8 ¾"
 Fig. 4

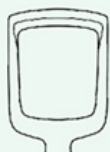

Beckmann

18-470-22

straight
gerade
recto
droit
rette



18-471-22



18-472-22 22 cm - 8 ¾"

18-473-22

curved
gebogen
curvo
courbe
curve

18-474-22

18-475-22 22 cm - 8 ¾"

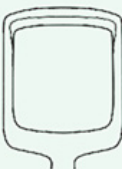

18-476-22

straight
gerade
recto
droit
rette

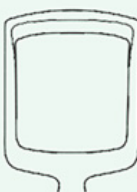

18-477-22

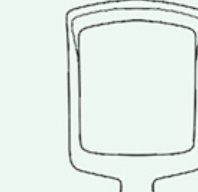

18-478-22 22 cm - 8 ¾"

18-479-22

curved
gebogen
curvo
courbe
curve

18-480-22

18-481-22 22 cm - 8 ¾"

Adenoid curettes
 Ringmesser
 Cuchillos para vegetaciones adenoides
 Couteaux à végétations adénoïdes
 curette adenoidi

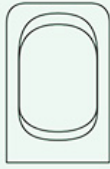

La Force
 18-482-25
 Fig. 1
 25 cm - 7"

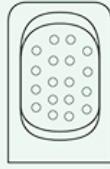

18-483-25

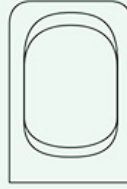

18-484-25
 Fig. 2
 25 cm - 7"

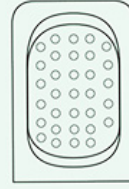

18-485-25

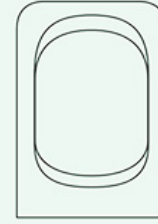

18-486-25
 Fig. 3
 25 cm - 7"

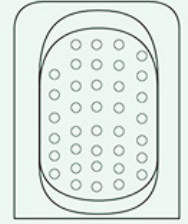

18-487-25

18-488-00

Spare blades
 Ersatzklingen
 Hojas de cambio
 Lames de rechange
 Lame di ricambio

18-489-00

18-490-00

18-491-00

18-492-00

18-493-00



Ballenger

18-494-01

18-494-02

18-494-03

20 cm - 8"
 straight
 gerade
 recto
 droit
 rette

18-495-01

18-495-02

18-495-03

20 cm - 8"
 bayonet
 bajonett
 bayoneta
 baionette
 baionetta

x = 3 mm

x = 4 mm

x = 5 mm



Kabierske

18-496-00

Atomizer, complete
Pulverbläser, komplett
Pulvérisateur, complet
Pulverizador, completo
Insoffiatore, completo

18-497-00

Spare bottle, 30 ccm
Ersatzflasche, 30 ccm
Flacon de rechange, 30 ccm
Frasco suelto, 30 ccm
Bottiglia di ricambio, 30 ccm

18-498-00

Valve rubber bulb
Ventilball
Poire en caoutchouc avec valve
Pera de goma con valva
Pallone in gomma con valva

Kabierske

18-499-08

8 cm - 3 ¼"

18-499-11

11 cm - 4 ¼"

18-500-13 13 cm - 5"

Cannula, straight
Kanüle gerade
Cánula recta
Canule droit
Cannula retta

Cannula, curved
Kanüle gebogen
Cánula curva
Canule courbe
Cannula curva



Universal

18-501-00

Atomizer, complete with movable tube, bottle 30 ccm
Pulverbläser, komplett mit beweglicher Düse, Flasche 30 ccm
Pulverizador, completo con tubo móvil, botella 30 ccm
Pulvérisateur, complet avec tuyère mobile, flacon 30 ccm
Insoffiatore, completo con ugello mobile, bottiglia 30 ccm



Politzer

18-502-00

complete with 3 nasal olives
 komplett mit 3 Nasenoliven
 completo con 3 olivas nasales
 complet avec 3 olives nasales
 completo con 3 olive nasali

18-503-00	nasal olive	15 mm Ø
18-504-00	nasal olive	17 mm Ø
18-505-00	nasal olive	22 mm Ø



18-503-00

15 mm Ø
 Nasal olives
 Nasenoliven
 Olivas nasales
 Olives nasales
 Olive nasali



18-504-00

17 mm Ø



18-505-00

22 mm Ø



18-506-00

4 mm Ø
 Ear olive
 Ohrolive
 Oliva auricular
 Olive auriculaire
 Oliva auricolare

18-507-00

15 mm Ø
 Rubber bulb with connecting nozzle
 Gummibirne mit Einsteckkonus
 Pera de goma con cono de conexión
 Poire en caoutchouc avec embout de raccordement
 Pera in gomma con cono di connessione

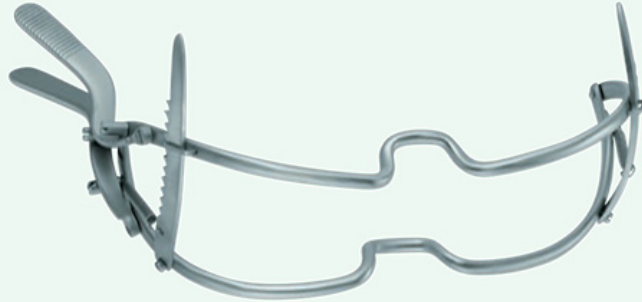

Whitehead

18-508-11	11 cm - 4 ¼"
18-508-13	13 cm - 5"
18-508-15	15 cm - 6"



Jennings

18-509-09	9 cm - 3 ½"
18-509-11	11 cm - 4 ¼"
18-509-13	13 cm - 5"
18-509-15	15 cm - 6"



Maunder

18-510-10 10 cm - 4"

4 mm Ø
Wood
Holz
Madera
Bois
Legno



Heister

18-511-13 13 cm - 5"



Molt
18-512-11 11 cm - 4 ¼"
For children
Für Kinder
Para niños
Pour enfants
Per bambini



Molt
18-513-14 14 cm - 5 ½"
For adults
Für Erwachsene
Para adultos
Pour adultes
Per adulti



Denhart
18-514-12 12 cm - 4 ¾"



Fergusson-Ackland
18-515-14 14.5 cm - 5 ¾"



Roser-König
18-516-16 16 cm - 6 ¼"
18-516-19 19 cm - 7 ½"

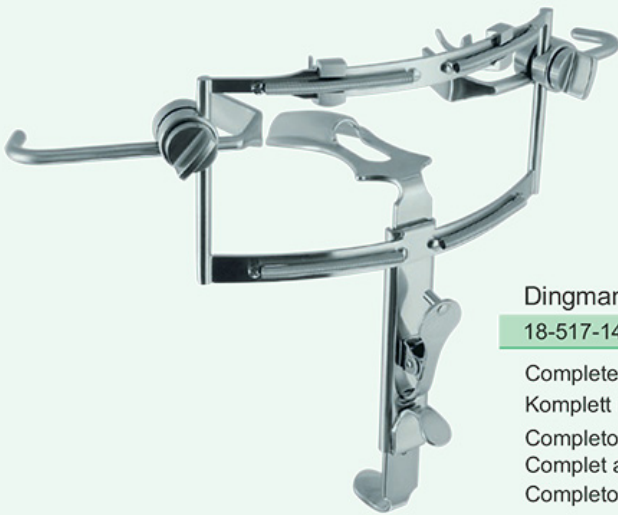

Dingmann

18-517-14 14.5 cm - 5 ¾"

Complete with frame, 3 tongue depressors and 2 adjustable lateral blades

Komplett mit Rahmen, 3 Zungenspateln und 2 beweglichen Seitenvalven

Completo con bastidor, 3 bajalenguas y 2 valvas laterales ajustables

Complet avec cadre, 3 abaisse-langues et 2 valves latérales réglables

Completo con telaio, 3 abassalingua e 2 valve laterali movibili

18-518-00 - 18-520-00



18-518-00

55 x 25 mm



18-519-00

60 x 27 mm



18-520-00

70 x 30 mm

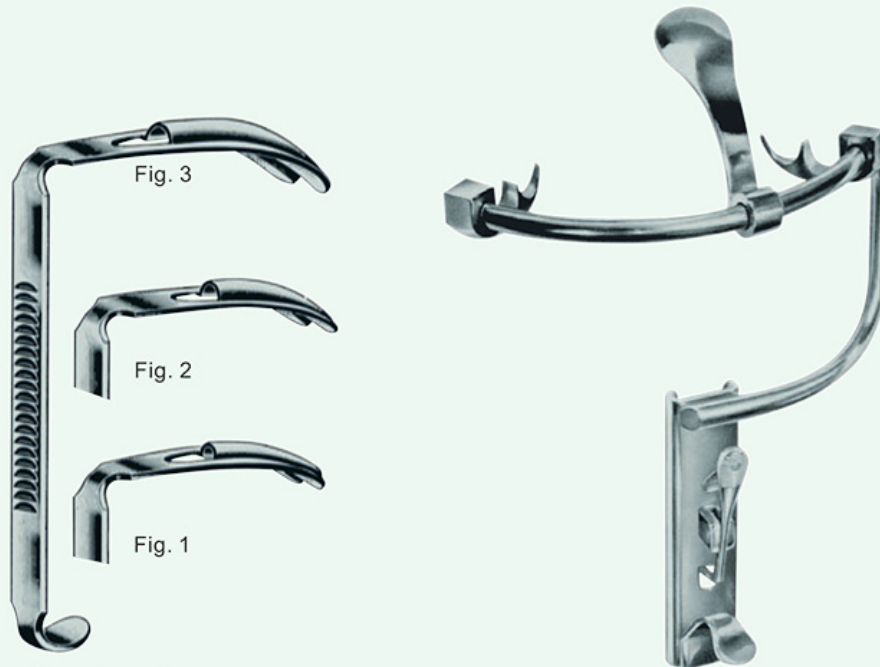

Kilner-Doughty

18-521-01

Fig. 1
 28 mm x 65 mm

18-522-02

Fig. 2
 32 mm x 75 mm

18-523-03

Fig. 3
 37 mm x 80 mm

18-524-00

Handle
 Griff
 Mango
 Manche
 Manico

18-525-00

Complete set consisting:
 18-521-01, 18-522-02, 18-523-03, 18-524-00

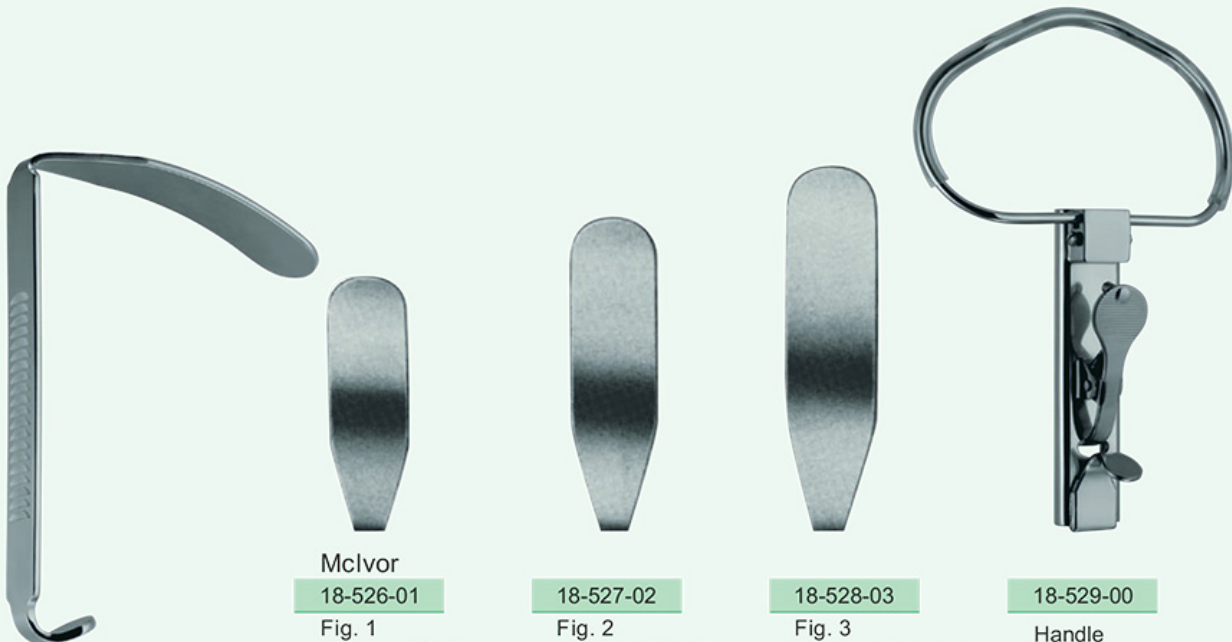

McIvor

18-526-01

Fig. 1
 23 mm x 70 mm

18-527-02

Fig. 2
 25 mm x 86 mm

18-528-03

Fig. 3
 26 mm x 100 mm

18-529-00

Handle
 Griff
 Mango
 Manche
 Manico

18-530-00

Complete set consisting:
 18-526-01, 18-527-02, 18-528-03, 18-529-00



Davis-Boyle

18-531-01

Fig. 1
21 mm x 26 mm

18-532-02

Fig. 2
23 mm x 65 mm

18-533-03

Fig. 3
24 mm x 80 mm

18-534-04

Fig. 4
25 mm x 93 mm

18-535-05

Fig. 5
26 mm x 108 mm

18-536-00

Handle
Griff
Mango
Manche
Manico

18-537-00

Complete set consisting:
18-531-01, 18-532-02, 18-533-03, 18-534-04,
18-535-05, 18-536-00



Negus

18-538-01

Fig. 1
20 mm x 70 mm

18-539-02

Fig. 2
30 mm x 80 mm

18-540-03

Fig. 3
33 mm x 95 mm

18-541-00

Handle
Griff
Mango
Manche
Manico

18-542-00

Complete set consisting:
18-538-01, 18-539-02, 18-540-03, 18-541-00



Larygeal

18-543-00	Fig. 00	08 mm Ø
18-543-12	Fig. 0	10 mm Ø
18-543-01	Fig. 1	12 mm Ø
18-543-02	Fig. 2	14 mm Ø
18-543-03	Fig. 3	16 mm Ø
18-543-04	Fig. 4	18 mm Ø
18-543-05	Fig. 5	20 mm Ø
18-543-06	Fig. 6	22 mm Ø
18-543-07	Fig. 7	24 mm Ø
18-543-08	Fig. 8	26 mm Ø
18-543-09	Fig. 9	28 mm Ø
18-543-10	Fig. 10	30 mm Ø



Handle

18-544-10

10 cm - 4"



Larygeal Modified

18-545-11	Fig. 00	08 mm Ø
18-545-12	Fig. 0	10 mm Ø
18-545-01	Fig. 1	12 mm Ø
18-545-02	Fig. 2	14 mm Ø
18-545-03	Fig. 3	16 mm Ø
18-545-04	Fig. 4	18 mm Ø
18-545-05	Fig. 5	20 mm Ø
18-545-06	Fig. 6	22 mm Ø
18-545-07	Fig. 7	24 mm Ø
18-545-08	Fig. 8	26 mm Ø
18-545-09	Fig. 9	28 mm Ø
18-545-10	Fig. 10	30 mm Ø



Michel

18-446-01 10 mm Ø

18-446-02 12 mm Ø

18-446-03 14 mm Ø

18-446-04 16 mm Ø

18-446-05 18 mm Ø

25 cm - 9 3/4"

moveable mirror
 Spiegel beweglich
 espejeo movable
 miroir mobile
 specchio mobile



Reichert
18-547-23 23 cm - 9"

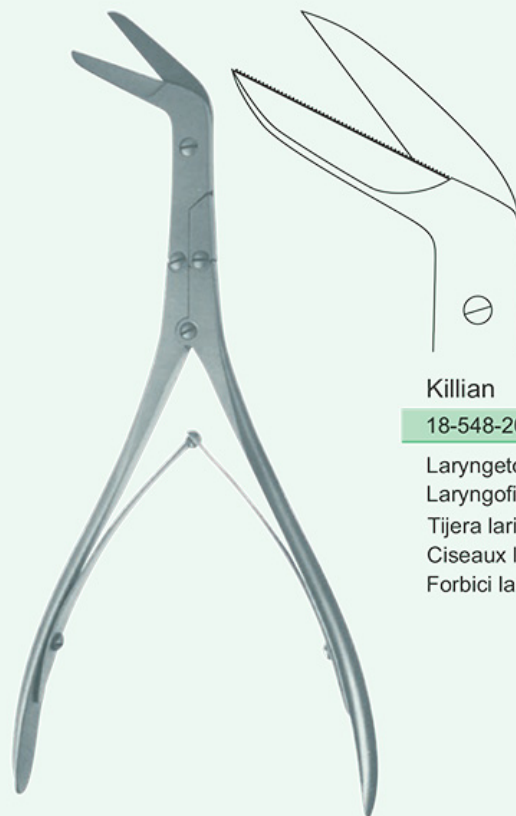

Killian
18-548-20 20 cm - 8"

Laryngotomy scissors
Laryngofissurschere
Tijera laringea
Ciseaux laryngiens
Forbici laringee

Tonsil snares
 Tonsillenschnürer
 Cierra-nudos para amigdales
 Serre noeuds pour amygdales
 lacci delle tonsille

surgimax™
 saving lives

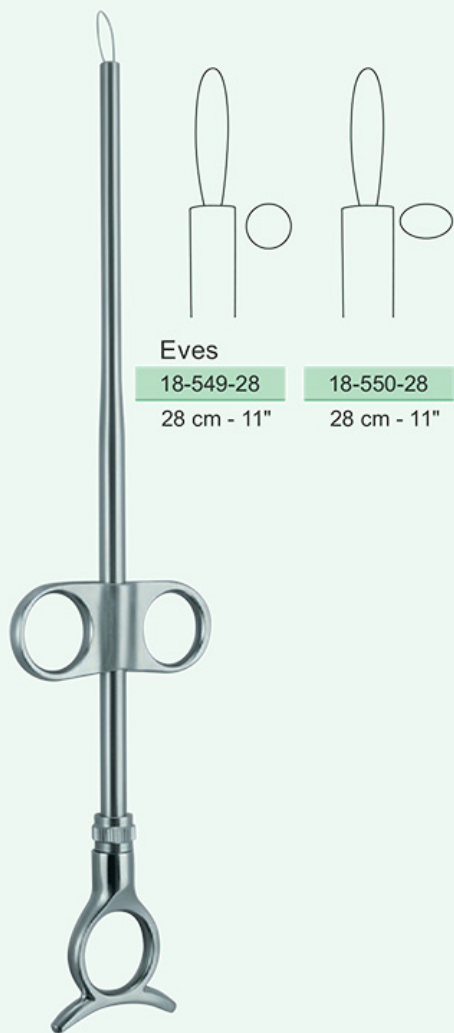

Eves

18-549-28

28 cm - 11"

18-550-28

28 cm - 11"



Eves Modified

18-551-28

28 cm - 11"



Bruenings

18-552-28

28 cm - 11"



18-553-01 0.3 mm Ø

18-553-02 0.4 mm Ø

10 meter - 33ft.



18-554-01 40 mm

18-554-02 50 mm



package of 100 pieces
 Packung mit 100 Stück
 paquete de 100 piezas
 paquet de 100 pièces
 pacchetto da 100 pezzi

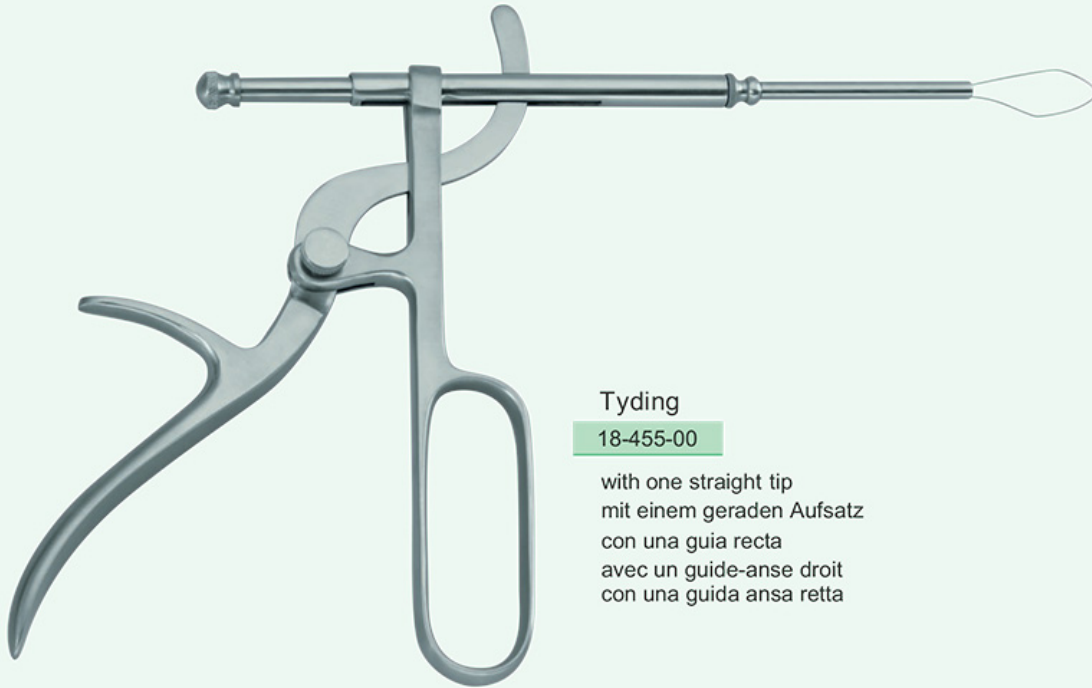

Tyding

18-455-00

with one straight tip
mit einem geraden Aufsatz
con una guida recta
avec un guide-anse droit
con una guida ansa retta



Tyding

18-456-00 0.4 mm Ø x 10 cm



package of 100 pieces
Packung mit 100 Stück
paquete de 100 piezas
paquet de 100 pièces
pacchetto da 100 pezzi

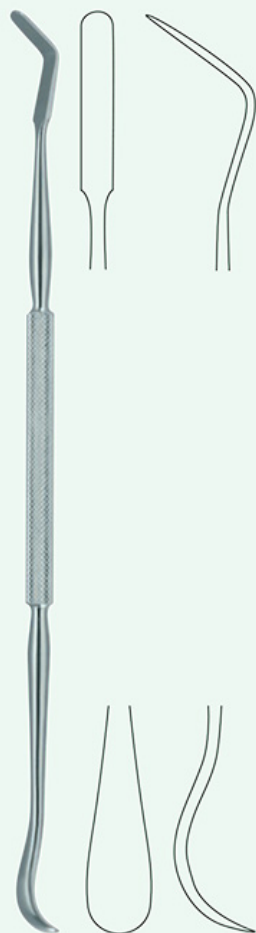

Carpenter

18-557-25

25 cm - 9 3/4"

Enucleator
 Enukleator
 Enucleador para amígdalas
 Encléateur pour amygdales
 Enucleatore

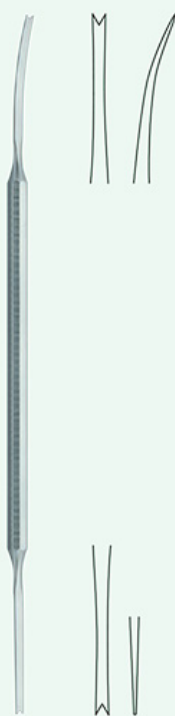

Luniatschek

18-558-18

18 cm - 7"

Tonsil tampon plugger
 Tonsillen-Tamponstopfer
 Porta algodones
 Porta cotton
 Porta tamponi

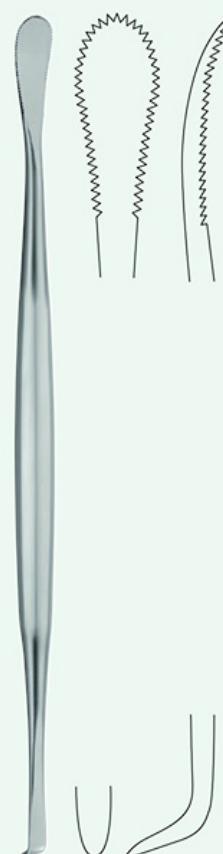

Henke

18-559-23

23 cm - 9"

Tonsil dissector
 Tonsillendissektor
 Disector para amígdalas
 Dissecteur à amygdales
 Dissettore tonsillare



Henke

18-560-23

23 cm - 9"

Tonsil dissector
 Tonsillendissektor
 Disector para amígdalas
 Dissecteur à amygdales
 Dissettore tonsillare



Hurd

18-561-22

22.5 cm - 8 ¾"

Tonsil dissector
Tonsillendisektor
Disector para amígdalas
Dissecteur à amygdales
Dissettore tonsillare



Mollison

18-656-21 21 cm - 8 ¼"

Pillar retractor



Lewis

18-562-19 19.5 cm - 7 ¾"

Tonsil screw
Tonsillenschraube
Tira amígdalas
Tire amygdales
Fissa tonsille



Marschik

18-563-22 22 cm - 8 ¾"

Tonsil seizing forceps
Tonsillen-Fasspinzette
Pinza prensora de amígdalas
Pince pour saisir les amygdales
Pinza da presa tonsille



Blohmke

18-564-20 20 cm - 8"



Colver

18-565-19

19 cm - 7 1/2"
 straight
 gerade
 recta
 droit
 retta

18-466-19

19 cm - 7 1/2"
 curved
 gebogen
 curva
 courbe
 curva



White

18-567-18

18 cm - 7"

18-567-23

23 cm - 9"

6 x 5

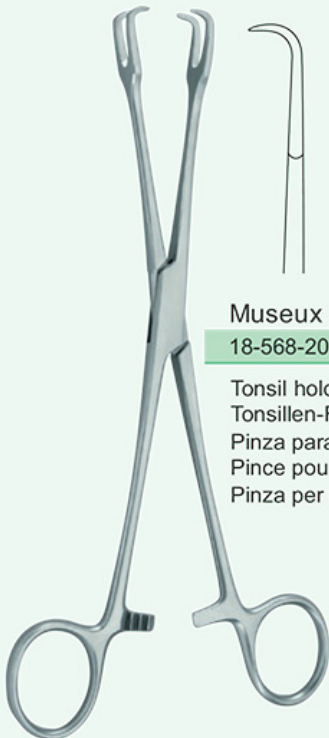

Museux

18-568-20 20 cm - 8"

Tonsil holding forceps
 Tonsillen-Fasszange
 Pinza para amígdalas
 Pince pour amygdales
 Pinza per tonsille



Jackson

18-569-22 22 cm - 8 3/4"

Laryngeal forceps
 Kehlkopfpinzette
 Pinza laringea
 Pince laryngienne
 Pinza laringea

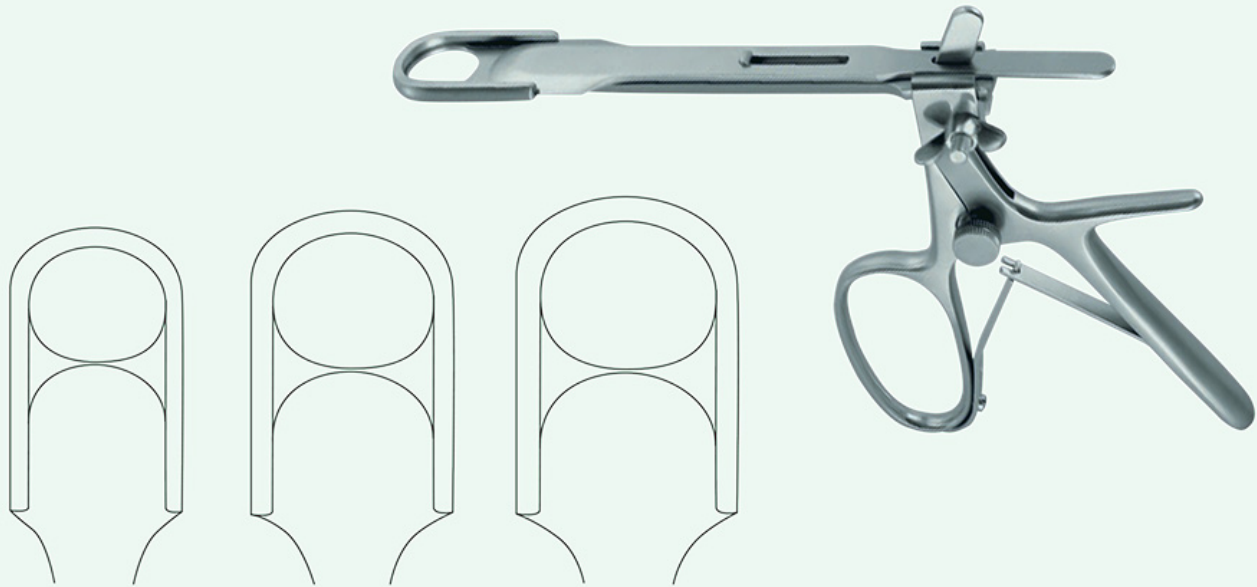

Sluder-Ballenger

18-570-01

Fig. 1

18-571-02

Fig. 2

18-572-03

Fig. 3

18-573-00

Handle
Griff
Mango
Manche
Manico

18-574-00

Complete set consisting:
18-570-01, 18-571-02, 18-572-03, 18-573-00

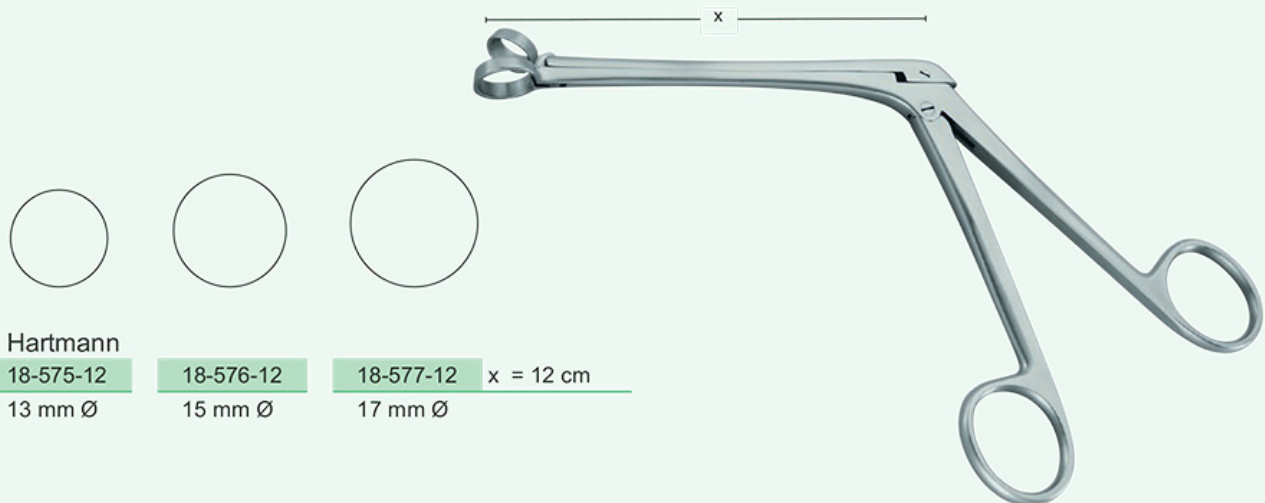

Hartmann

18-575-12

13 mm Ø

18-576-12

15 mm Ø

18-577-12

17 mm Ø

x = 12 cm



Laborde

18-578-14 14 cm - 5 ½"

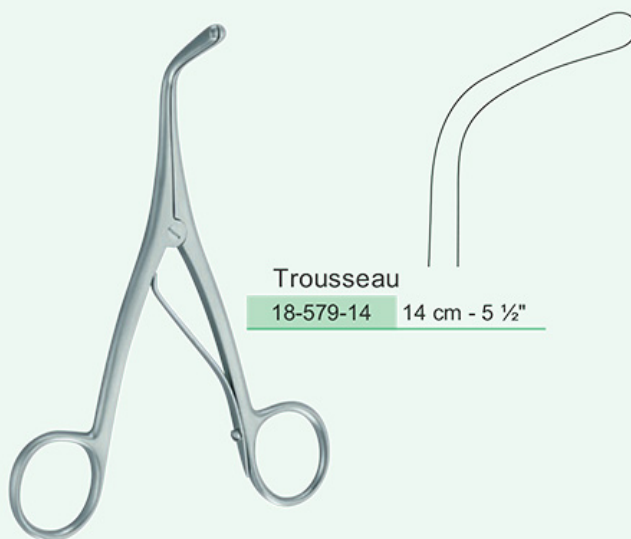

Trousseau

18-579-14 14 cm - 5 ½"



Luer Standard

18-580-00	Fig. 0	4 mm Ø
18-580-01	Fig. 1	5 mm Ø
18-580-02	Fig. 2	6 mm Ø
18-580-03	Fig. 3	7 mm Ø
18-580-04	Fig. 4	8 mm Ø
18-580-05	Fig. 5	9 mm Ø
18-580-06	Fig. 6	10 mm Ø
18-580-07	Fig. 7	11 mm Ø
18-580-08	Fig. 8	12 mm Ø
18-580-09	Fig. 9	13 mm Ø

German silver
Neusilber
Plata alemana
Maillechort
Argentone



Uckermann

18-581-22

13 cm - 5"
10 mm Ø



Chevalier-Jackson

18-582-00	Fig. 0	4 mm Ø
18-582-01	Fig. 1	5 mm Ø
18-582-02	Fig. 2	6 mm Ø
18-582-03	Fig. 3	7 mm Ø
18-582-04	Fig. 4	8 mm Ø
18-582-05	Fig. 5	9 mm Ø
18-582-06	Fig. 6	10 mm Ø
18-582-07	Fig. 7	11 mm Ø
18-582-08	Fig. 8	12 mm Ø
18-582-09	Fig. 9	13 mm Ø

German silver
Neusilber
Plata alemana
Maillechort
Argentone

Kropffasszangen – Kropfsonden
 Goitre grasping forceps – Goitre enucleator
 Pinces à goitre – Spatules à goitre
 Pinzas para coger el bocio – Sonidas para bocio
 Kropffasszangen - Kropfsonden



Mastin
 18-583-17 17 cm - 6 ½"



Lahey
 18-584-15 15 cm - 6"
 18-584-20 20 cm - 8"



Kocher
 18-585-15 18-586-15 15 cm - 6"
 18-585-16 18-586-16 16 cm - 6 ¼"

with hole
 mit Loch
 con orificio
 avec trou
 con foro



Bruenings

18-587-20	20 cm - 8"
18-587-30	30 cm - 12"
18-587-40	40 cm - 16"
18-587-50	50 cm - 20"
18-587-60	60 cm - 23 1/2"

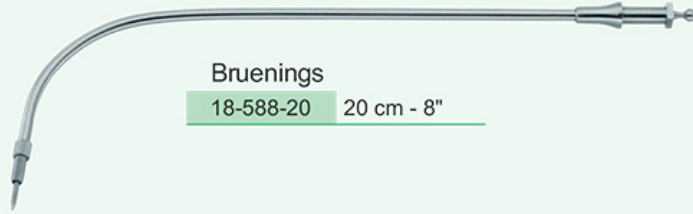

Bruenings

18-588-20	20 cm - 8"
-----------	------------



Huber
18-589-00



Seiffert
18-590-00



Bruenings
18-591-00 18-592-00 18-593-00

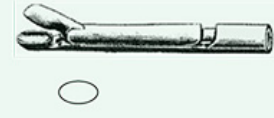

Lange
18-594-00

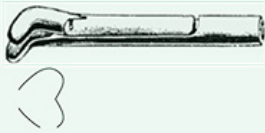

Scheinmann
18-595-00

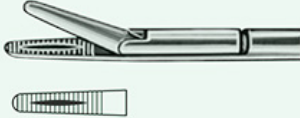

Fraenkel
18-596-00



18-597-01 18-598-01

18-599-02 18-600-02



Krause
18-601-00



Cordes
18-602-00 18-603-00

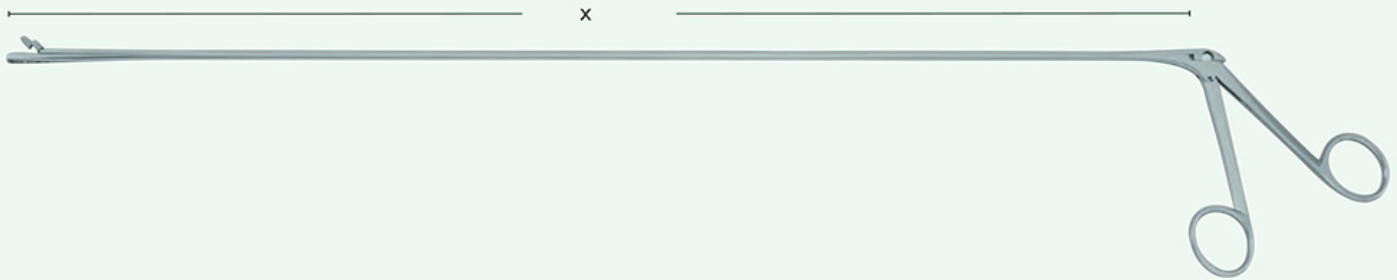

Chevalier-Jackson

18-675-30
18-675-40
18-675-50
18-675-60



18-676-30
18-676-40
18-676-50
18-676-60



18-677-30
18-677-40
18-677-50
18-677-60



18-678-30	x = 30 cm - 12"
18-678-40	x = 40 cm - 16"
18-678-50	x = 50 cm - 20"
18-678-60	x = 60 cm - 23 ½"



Chevalier-Jackson

18-604-30
18-604-40
18-604-50
18-604-60



18-605-30
18-605-40
18-605-50
18-605-60



18-606-30	x = 30 cm - 12"
18-606-40	x = 40 cm - 16"
18-606-50	x = 50 cm - 20"
18-606-60	x = 60 cm - 23 ½"

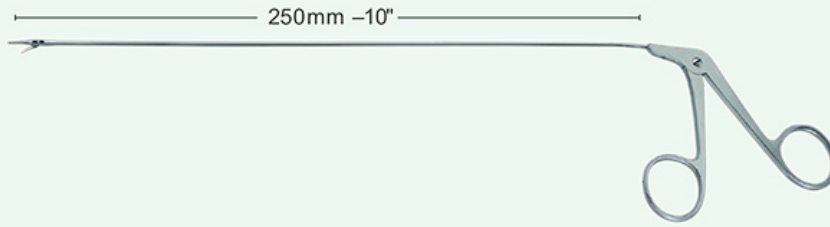

Gotan

18-607-00



18-608-00



18-609-00



18-610-00



18-611-00



18-612-00

Scissors
Scheren
Tijeras
Ciseaux
Forbice

straight
gerade
recta
droit
retta

straight horizontal
gerade horizontal
recta horizontal
droit horizontal
retta orizzontale

angled up horizontal
aufgebogen horizontal
curvada arriba horizontal
coudé en haut coupe horizontal
curvata in alto orizzontale

curved right
rechts gebogen
curvada a derecha
courbe à droite
curva a destra

curved left
links gebogen
curvada a izquierda
courbe à gauche
curva a sinistra

angled up
aufgebogen
curvada arriba
coudé en haut
curvata in alto



18-613-00



18-614-00



18-615-00



18-616-00



18-617-00

Alligator forceps
Alligatorzangen
Pinzas cocodrilo
Pincers crocodile
Pinze cocodrillo

straight, serrated
gerade, gerieft
recta, estriada
droit, strié
retta, zigrinata

straight horizontal
gerade horizontal
recta horizontal
droit horizontal
retta orizzontale

angled up horizontal
aufgebogen horizontal
curvada arriba horizontal
coudé en haut coupe horizontal
curvata in alto orizzontale

curved right
rechts gebogen
curvada a derecha
courbe à droite
curva a destra

curved left
links gebogen
curvada a izquierda
courbe à gauche
curva a sinistra



18-618-00



18-619-00



18-620-00



18-621-00



18-622-00

○ 2.5 mm

Cup shaped forceps
Löffelzangen
Pinzas cureta
Pincers currettes
Pinze a cucchaio

straight
gerade
recta
droit
retta

angled up
aufgebogen
curvada arriba
coudé en haut
curvata in alto

angled up horizontal
aufgebogen horizontal
curvada arriba horizontal
coudé en haut coupe horizontal
curvata in alto orizzontale

curved right
rechts gebogen
curvada a derecha
courbe à droite
curva a destra

curved left
links gebogen
curvada a izquierda
courbe à gauche
curva a sinistra







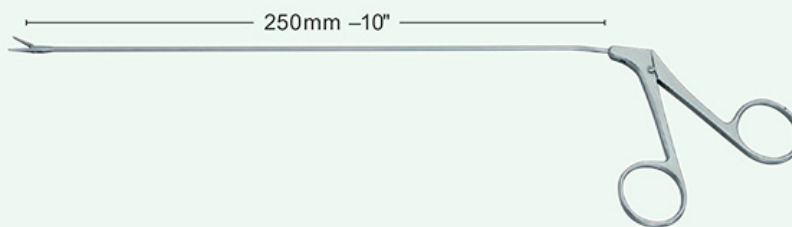

18-623-00





○ 3 x 5 mm

Cup shaped forc. oval
Löffelzange oval
Pinza cureta oval
Pince curette ovale
Pinza a cucchaio ovale



						
	Helmet					
	18-624-00	18-625-00	18-626-00	18-627-00	18-628-00	18-629-00
Scissors	straight	straight horizontal	angled up horizontal	curved right	curved left	angled up
Scheren	gerade	gerade horizontal	aufgebogen horizontal	rechts gebogen	links gebogen	aufgebogen
Tijeras	recta	recta horizontal	curvada arriba horizontal	curvada a derecha	curvada a izquierda	curvada arriba
Ciseaux	droit	droit horizontal	coudé en haut coupe horizontal	courbe à droite	courbe à gauche	coudé en haut
Forbice	retta	retta orizzontale	curvata in alto orizzontale	curva a destra	curva a sinistra	curvata in alto

					
	18-630-00	18-631-00	18-632-00	18-633-00	18-634-00
Alligator forceps	straight	straight horizontal	angled up horizontal	curved right	curved left
Alligatorzangen	gerade	gerade horizontal	aufgebogen horizontal	rechts gebogen	links gebogen
Pinzas cocodrilo	recta	recta horizontal	curvada arriba horizontal	curvada a derecha	curvada a izquierda
Pinces crocodile	droit	droit horizontal	coudé en haut coupe horizontal	courbe à droite	courbe à gauche
Pinze coccodrillo	retta	retta orizzontale	curvata in alto orizzontale	curva a destra	curva a sinistra

					
	18-635-00	18-636-00	18-637-00	18-638-00	18-639-00 ○ 2.5 mm
Cup shaped forceps	straight	angled up	angled up horizontal	curved right	curved left
Löffelzangen	gerade	aufgebogen	aufgebogen horizontal	rechts gebogen	links gebogen
Pinzas cureta	recta	curvada arriba	curvada arriba horizontal	curvada a derecha	curvada a izquierda
Pinces curettes	droit	coudé en haut	coudé en haut coupe horizontal	courbe à droite	courbe à gauche
Pinze a cucchaio	retta	curvata in alto	curvata in alto orizzontale	curva a destra	curva a sinistra

	18-640-00 ○ 3 x 5 mm
Cup shaped forceps, oval	
Löffelzange, oval	
Pinza cureta, oval	
Pinze curette, ovale	
Pinza a cucchaio ovale	

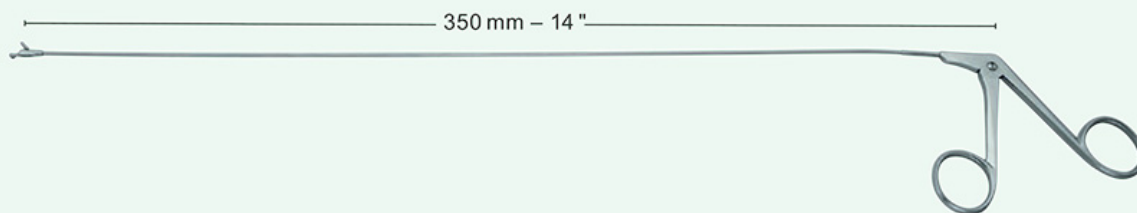

Bukshire
18-641-00

Grasping forceps
Fasszange
Pinza agarre
Pince à saisir
Pinza da presa

straight, serrated
gerade, gerieft
recta, estriada
droit, striée
retta, zigrinata



18-642-00

straight, fenestrated
gerade, gefenstert
recta, fenestrada
droit, fenêtrée
retta, fenestrata



18-643-00

straight
gerade
recta
droits
retta



18-644-00

Cup shaped forceps
Löffelzangen
Pinzas cureta
Pincas currettes
Pinze a cucchaio

straight
gerade
recta
droit
retta



18-645-00

angled up
aufgebogen
curvada arriba
coudée en haut
curvata in alto



18-646-00

angled up horizontal
aufgebogen horizontal
curvada arriba horizontal
coudée en haut
curvata in alto orizzontale



18-647-00

curved right
rechts gebogen
curvada a derecha
courbe à droite
curva a destra



18-648-00

curved left
links gebogen
curvada a izquierda
courbe à droite
curva a sinistra

○ 3 mm



18-649-00

Cup shaped forceps
Löffelzangen
Pinzas cureta
Pincas currettes
Pinze a cucchaio

2 mm x 5 mm
straight
gerade
recta
droit
retta



18-650-00

3 mm x 5 mm
straight
gerade
recta
droit
retta



18-651-00

Universal forceps
Universalzange
Pinza universal
Pince universelle
Pinza universale

straight
gerade
recta
droit
retta

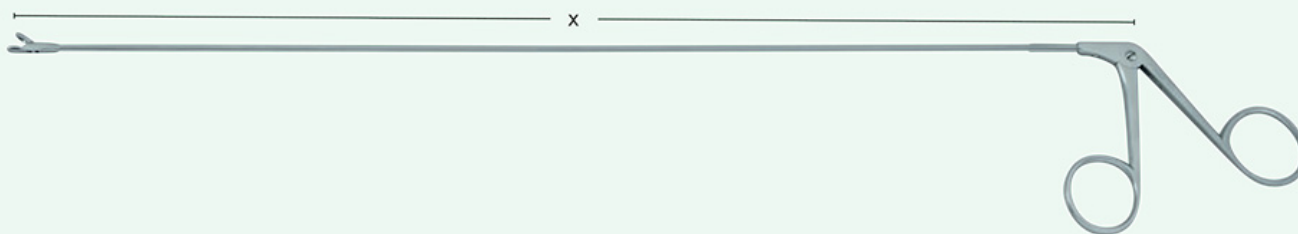

Gibtek

18-652-40	x = 40 cm - 16"
18-652-50	x = 50 cm - 20"
18-652-60	x = 60 cm - 23 ½"

Punch forceps, straight
 Tumorzange, gerade
 Pinza para tumores, recta
 Pince pour tumeurs, droit
 Pinza per tumori, retta

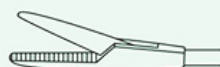

18-653-40
18-653-50
18-653-60

Grasping forceps
 Fasszangen
 Pinzas agarre
 Pincés à saisir
 Pinze da presa

straight, serrated
 gerade, gerieft
 recta, estriada
 droit, striée
 retta, zigrinata



18-654-40
18-654-50
18-654-60

straight, fenestrated
 gerade, gefenstert
 recta, fenestrada
 droit, fenêtrée
 retta, finestra



18-655-40	x = 40 cm - 16"
18-655-50	x = 50 cm - 20"
18-655-60	x = 60 cm - 23 ½"

straight
 gerade
 recta
 droit
 retta



Makson

18-656-40

18-656-50

18-656-60

4 mm
straight
gerade
recta
droit
retta



18-657-40

18-657-50

18-657-60

4 mm
angled up
aufgebogen
curvada arriba
coudée en haut
curvata in alto



18-658-40

18-658-50

18-658-60

4 mm
angled up horizontal
aufgebogen horizontal
curvada arriba horizontal
coudée en haut coupe horizontalement
curvata orizzontalmente



18-659-40 x = 40 cm - 16"

18-659-50 x = 50 cm - 20"

18-659-60 x = 60 cm - 23 1/2"

4 mm
curved right
rechts gebogen
curvada a derecha
courbe à droite
curva a destra

Cup shaped forceps
Löffelzangen
Pinzas cureta
Pinces à curette
Pinze a cucchaio



18-660-40

18-660-50

18-660-60

4 mm
curved left
links gebogen
curvada a izquierda
courbe à gauche
curva a sinistra



18-661-40

18-661-50

18-661-60

3 mm x 4 mm
straight
gerade
recta
droit
retta



18-662-40

18-662-50

18-662-60

4 mm x 6 mm
straight
gerade
recta
droit
retta



18-663-40 x = 40 cm - 16"

18-663-50 x = 50 cm - 20"

18-663-60 x = 60 cm - 23 1/2"

4 mm x 8 mm
straight
gerade
recta
droit
retta

Cup shaped forceps
Löffelzangen
Pinzas cureta
Pinces mors curettes
Pinze a cucchaio



18-664-40 x = 40 cm - 16"

18-664-50 x = 50 cm - 20"

18-664-60 x = 60 cm - 23 1/2"

Universal forceps
Universalzange
Pinza universal
Pince universelle
Pinza universale

straight
gerade
recta
droit
retta

Laryngeal polypus forceps
 Kehlkopfpolypenzangen
 Pinzas para pólipos laringeos
 Pinces à polypes laryngiens
 Pinze polipi laringei

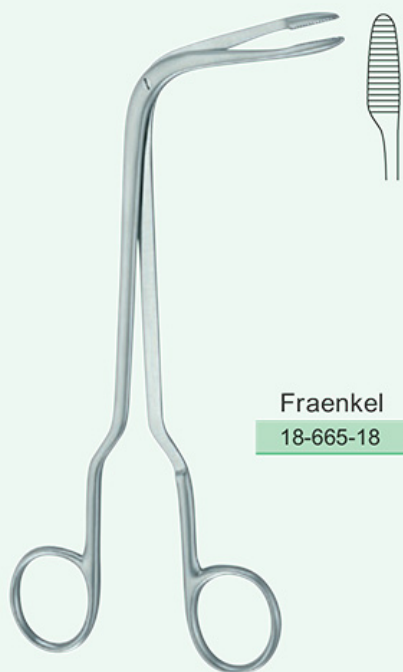

Fraenkel

18-665-18 18 cm - 7"



Jurasz

18-666-23

right
 rechts
 a derecha
 à droite
 verso destra

18-667-23 23 cm - 9"

left
 links
 a izquierda
 à gauche
 verso sinistra



18-668-00

downwards
 nach unten
 hacia abajo
 vers le bas
 verso basso



18-669-00

upwards
 nach oben
 hacia arriba
 vers le haut
 verso alto

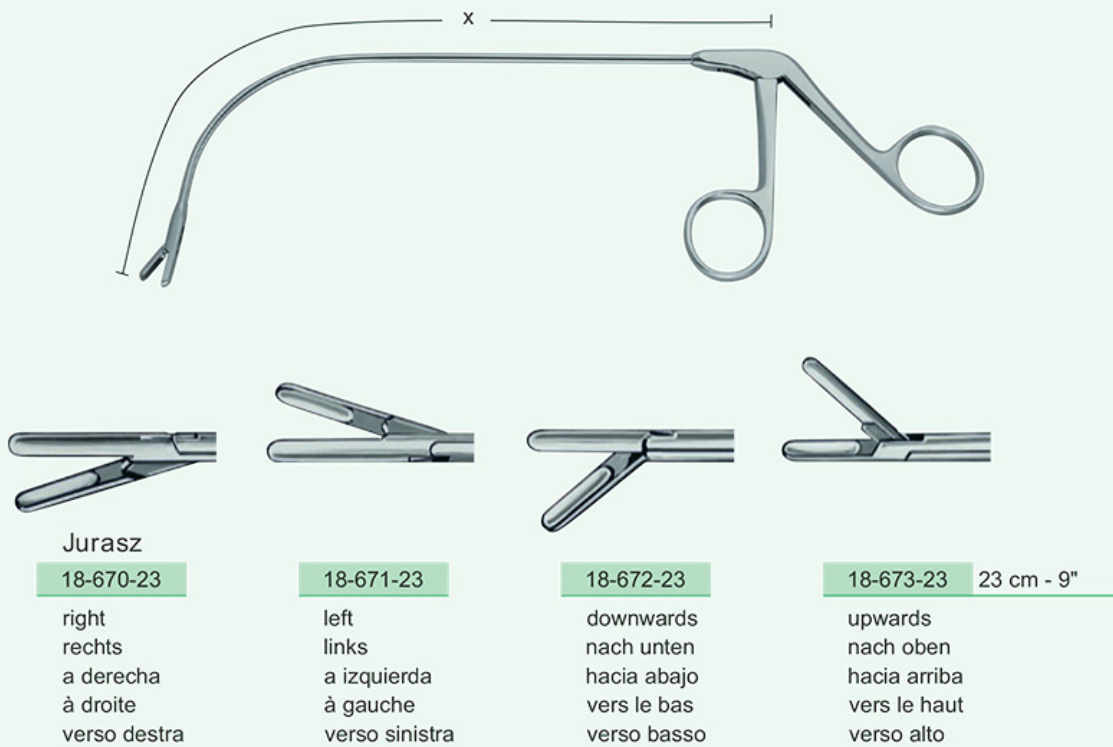

Laryngeal polypus forceps
Kehlkopfpolypenzangen
Pinzas para pólipos laringeos
Pinces à polypes laryngiens
Pinze polipi laringei

surgimax™
saving lives

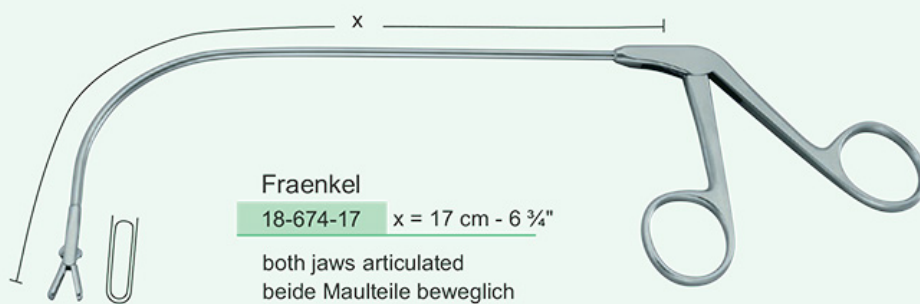

Fraenkel

18-674-17 x = 17 cm - 6 ¾"

both jaws articulated
beide Maulteile beweglich
las dos mandíbulas móviles
les deux mâchoires mobiles
ambedue i morsi mobili